

Builders Know The Difference.

Specification Catalog





The Vector Difference.

At Vector, we believe hard work and a “get-it-done” attitude are the secrets to lasting success. That’s something we learned from professional builders. We also learned to take pride in our work and that excuses aren’t an option.

It’s that uncompromising commitment to builders that informs our unparalleled service and exceptional craftsmanship. With Vector, you’ll find quality windows and doors that help builders achieve better results with quick delivery times, personalized service and minimal call backs.

If you’ve ever used our windows, you already know the difference we bring to the table. If you haven’t, we hope you’ll take this opportunity to see what all the fuss is about.

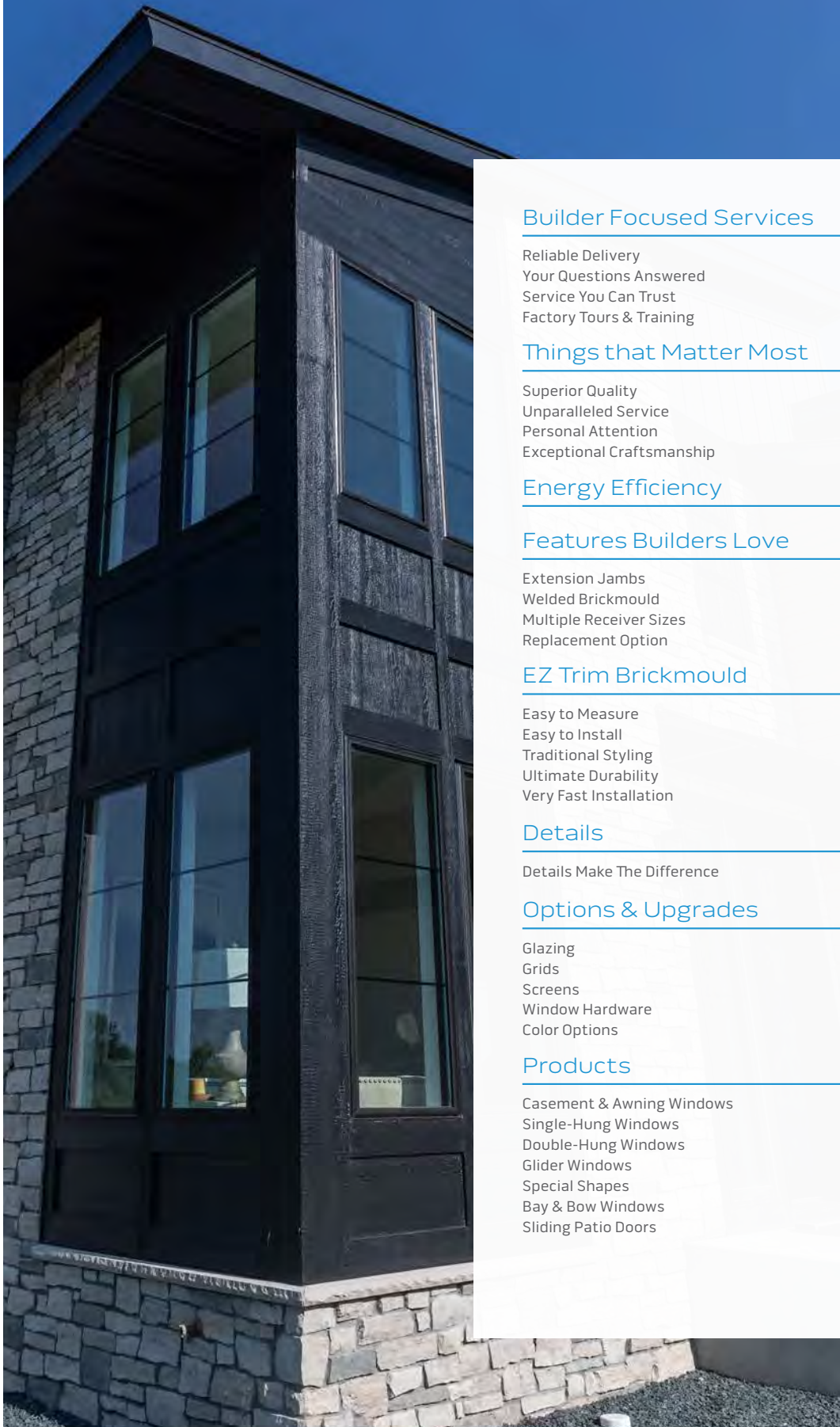

Builder Focused Services 3

- Reliable Delivery
- Your Questions Answered
- Service You Can Trust
- Factory Tours & Training

Things that Matter Most 4

- Superior Quality
- Unparalleled Service
- Personal Attention
- Exceptional Craftsmanship

Energy Efficiency 5

Features Builders Love 6

- Extension Jamb
- Welded Brickmould
- Multiple Receiver Sizes
- Replacement Option

EZ Trim Brickmould 7 – 8

- Easy to Measure
- Easy to Install
- Traditional Styling
- Ultimate Durability
- Very Fast Installation

Details 9

Details Make The Difference

Options & Upgrades 10 – 11

- Glazing
- Grids
- Screens
- Window Hardware
- Color Options

Products 11 – 26

- Casement & Awning Windows
 - Single-Hung Windows
 - Double-Hung Windows
 - Glider Windows
 - Special Shapes
 - Bay & Bow Windows
 - Sliding Patio Doors
- NVC
 - A-SH, NVH
 - NVDH
 - A-GL, NVG
 - A-SP, NVSP
 - NVBW
 - FVPD, FSD

- A-SH
- A-GL
- A-PW
- A-SP
- NVC
- NVH
- NVDH
- NVG
- NVPW
- NVSP
- NVBW
- FVPD
- FSD

Builder Focused Services

A Job Well Done Starts Here.

It's not enough to build great windows and doors. We value your time and provide reliable, on-time delivery with the service and support you need. At Vector, our priority is helping you get the job done right, without the hassle.



Reliable Delivery

You don't have time to wait around, not knowing when your windows & doors will arrive. That's why all of our standard products—including custom sizes—are available in industry leading lead times. When time is money, can you afford to waste yours?



Your Questions Answered

Need help with a difficult order? Not sure which product can get the job done best? Our engineering team is here for you. Call us, and one of our highly skilled engineers will answer the phone to give you the help you need.



Service You Can Trust

Vector's eService system allows builders or homeowners to make a service request or check the status of an existing request online, taking the hassle out of receiving service. We follow up every service request with a personal phone call and our service team works quickly to resolve your request.



Personal Attention

At Vector, we will work with you to meet your specific project needs and exceed your expectations. Since every order is unique, we pay close attention to the details that bring your vision to life. Each order is carefully constructed to ensure dependable deliveries.

The Things that Matter Most.



Superior Quality

Our products work right the first time, with easy installation and minimal maintenance backed with a limited lifetime warranty. This means you'll have few, if any, expensive call backs.



Exceptional Craftsmanship

We've been making high quality windows & doors for more than 25 years. We are proud of our work and the individual effort that goes into every single product we make.

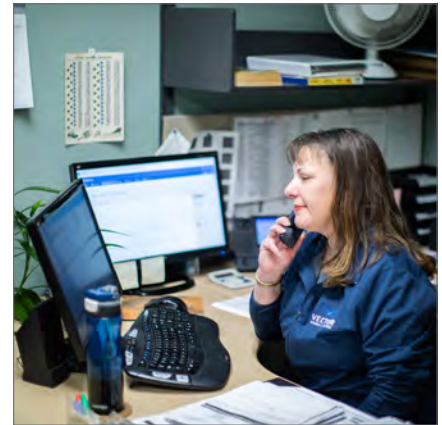

Unparalleled Service

Great service is at the heart of our culture at Vector. We're genuine people who will answer the phone when you call, and if there is ever a problem with our windows or doors, we will make it right, period.

Energy Efficient Alternative

Envision windows use Innergy Rigid Thermal Reinforcements instead of aluminum to improve window thermal and structural performance. Which helps reduce condensation and allows for more comfortable household humidity levels.

The High-Performing Alternative to Aluminum Inserts

Superior performance doesn't get much easier than this.

Innergy Rigid Thermal Reinforcements are advanced fiber glass reinforced resin inserts, designed to slide easily into window and door frame chambers for greater support and insulation.

The result is a new, more efficient system with all the strength and structural reinforcement of aluminum, but with a whole new set of high performance benefits for the home.

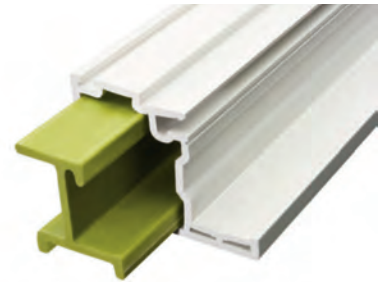

INNERGY
Rigid Thermal Reinforcements

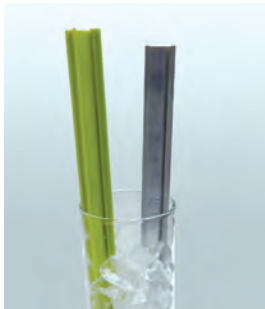

Innergy and Alluminum in a 32 degree ice bath

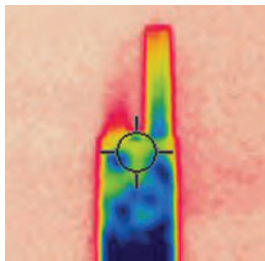

Photo taken after one hour ice bath

Innergy is the innovative, energy-efficient alternative to aluminum.

As the next-generation of thermal reinforcement for the industry, Innergy is able to deliver a quantum leap above aluminum in how windows perform:

Better thermal performance

Up to 700 times better than aluminum in material-to-material comparisons.

Better thermal break

Impervious to cold or heat

Better protection against condensation

Helps prevent staining that can occur with metal reinforcements

Better impact testing

Resistance to impact versus other reinforcement products

Better flexibility

Will not permanently set when impacted

Features Builders Love

A Joy to Work With.

They say beauty is only skin deep, and a great-looking product that's hard to install and difficult to maintain isn't much use to anyone. Vector windows & doors have been designed with builders in mind.

Extension Jamb

Wall thicknesses vary greatly. Vector windows come in a variety of custom jamb depths, so you can always create a perfect fit. Moreover, extension jamba are available applied or loose and come in a variety of wood or vinyl veneers.



Welded Brickmould

Our welded brickmould system allows Envision windows to be installed from the exterior. The snap-in cap completes the finished look and allows for fast, beautiful installation. It's easy-to-measure, lets you keep existing siding and can be installed by a single person.



Multiple Receiver Sizes

Vector windows can be equipped with either 5/8" or 3/4" receivers to accommodate the extension jamba you prefer to use. Receivers are pre-cut to length and can be shipped loose or pre-applied in our factory.

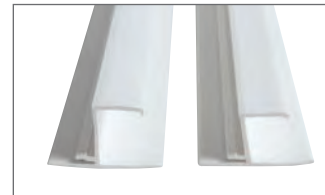

Incredibly Strong

You won't find any flimsy windows here. Envision windows have reinforced check rails and sashes to ensure they'll stand the test of time. For large windows, we include dual locks, ensuring a weather tight seal.

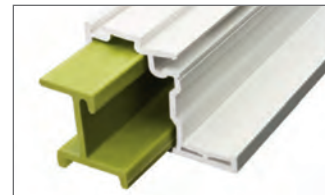

Replacement Option

Any of our windows can be ordered in custom sized 1/8" increments for a perfect fit. Choose our "Retro" configuration, and we'll remove the nail fin, drill the appropriate holes, provide plugs, screws and sill angle, so you'll have everything you need for the job.



EZ-Trim Brickmould

Easy to measure

Simply provide us with the dimensions of your existing wood brickmould trim, and we will custom build a window with EZ-Trim Brickmould to fit the opening.



Easy to Install

EZ-Trim has a convenient screw channel on the face of the product, which allows for installation from the exterior.

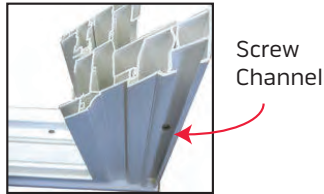

Traditional Styling

The 2" contoured top and sides and a 1" subsill give the appearance of traditional wood trim. (also available with 2" trim on all four sides)



Ultimate Durability

EZ-Trim also features welded corners, and a sturdy multi-chambered design for the ultimate in durability and performance.



Very Fast Installation

Installers love EZ-Trim Brickmould because it saves them a lot of time compared to traditional window replacement methods.



EZ-Trim is available in the following product lines:

Envision Series

- Double Hung
- Single Hung
- Gliders Casement
- Awning
- Picture Windows

Colors Available



EZ-Trim Brickmould

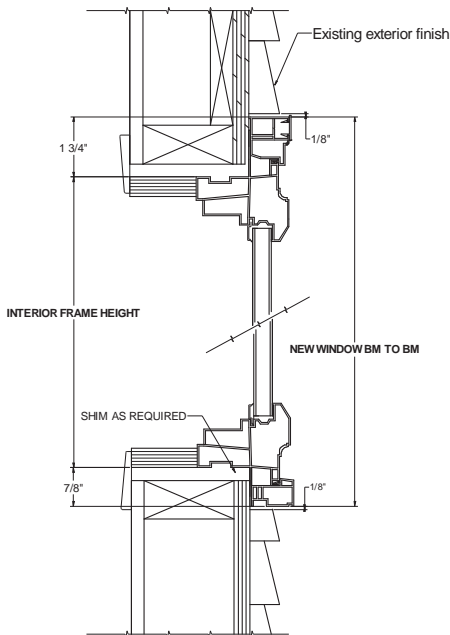

Window Replacement

Measuring Instructions

1. Measure exterior brickmould to brickmould for the width. Measurements should be taken in at least three different points, using the smallest of the three dimensions.
2. Deduct 1/4" on the width to determine BM to BM measurement. (This will allow for 1/8" caulk line on each side for the new window)
3. Measure the height from top of existing brickmould to the shortest part of the sill.
2. Deduct 1/4" on the height to determine BM to BM measurement. (This will allow for 1/8" caulk line on each side for the new window)

General Installation Guide:

1. Remove the existing window from the rough opening
2. Remove the nailfin that extends past the subsill on the new window by scoring it with a utility knife several times and then bend at score line to remove. This nailfin is left on to protect window during shipping.
3. Remove brickmold covers from the window using a putty knife. Place putty knife between brickmould and brickmould cover from the center side of the window. Gently push inward and then lift up on the putty knife, lifting the brickmould cover. Then pull the cover off by hand. Repeat this step for the remaining two brickmould covers. See Fig 1. for where to pry the covers off.
4. Install the window in accordance with good practice and required building codes.
5. Shim window as required to support the window to ensure it is level, square and plumb.
6. Secure the window in place by using the 3" pan head screw (provided with the window) through the brickmould as shown in the Fig. 1. Use the groove as a guide for proper screw placement.
7. Snap the cover provided into place to cover screws, trim as needed.
8. Caulk between the siding and brickmould.

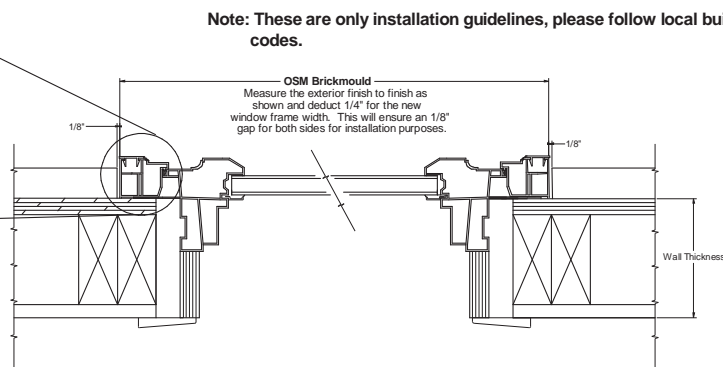
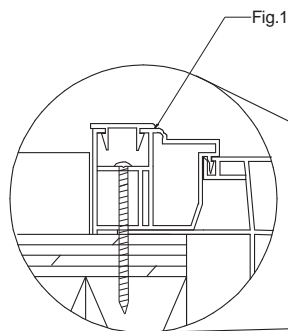

Note: These are only installation guidelines, please follow local building codes.

Notes:

- Exact window size will be 3 1/4" less than the OSM Brickmold (side jambs)
- Exact window size will be 2 1/2" less than the OSM Brickmould (head to subsill)
- Jamb depths in homes may vary. We suggest that you verify all openings.

BM to BM = Brickmould to Brickmould

OSM = Outside Measurement

Note: Not all replacement situations are the same. Some modifications may have to be made depending upon your installation situation.

Note: The Brickmould measurements you order width and height will be the size you receive.

Details Make the Difference.

Grids

Vector offers the ability to add a personalized touch to your doors and windows by adding grids between the glass. Pick your style with a Colonial, Prairie or Heritage pattern. Custom grid patterns are available upon request. Choose between our standard flat bar style or upgrade to our contoured grids for a more elegant sculptured look.

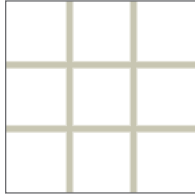

Colonial

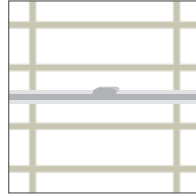

Prairie

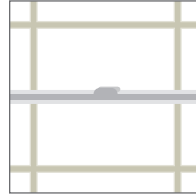

Special Prairie
(Heritage)

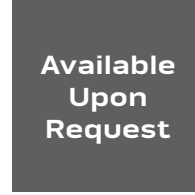

Custom Patterns



Contoured Grid



9/16" Flat Grid



1" Flat Grid

Screens

Half fiberglass screens come standard on single-hung and glider units, while double-hung windows come with full screens, as do casements and awning units. We also offer aluminum mesh, FlexScreens and Clearscene screen mesh as optional upgrades. Clearscene screens are a superior choice for keeping out bugs, while offering 50 percent more clarity than standard screens.



Window Hardware



Lock & Keeper

Available in color-coordinated finishes and warrantied to last a lifetime.



Folding Handle

Casement hardware folds down for an unobstructed view.



Night Latches

Let the fresh breeze in while limiting the sash opening.

Options & Upgrades

Master craftsmen know it's the smallest details that make a work of art something truly special. At Vector, we pay particular attention to those finishing touches.

Extension Jamb

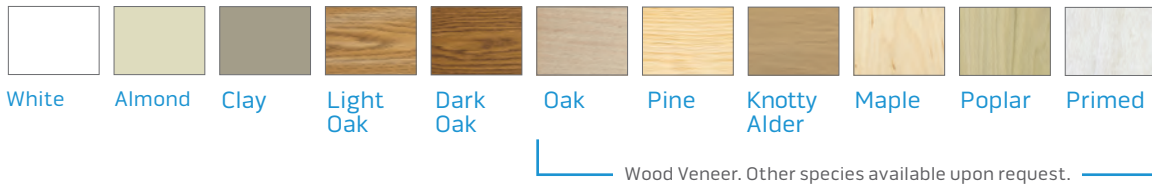

Glazing



Standard LoE Coating

Double-strength insulated glass filled with argon gas. Comes with a warm-edge spacer.



Obscure Glazing

Provides privacy while still allowing light through.



LoE³ Coating

Three layers of LoE to improve energy efficiency even further.

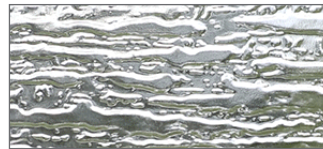

Specialty Glass

Tinted, rain, and other specialty glass is available upon request.



Tempered Glazing

To improve strength & safety.



Triple Pane Glass

The ultimate in glass efficiency is available in our Envision series windows.



Color Options & Upgrades

Advantage Color Options

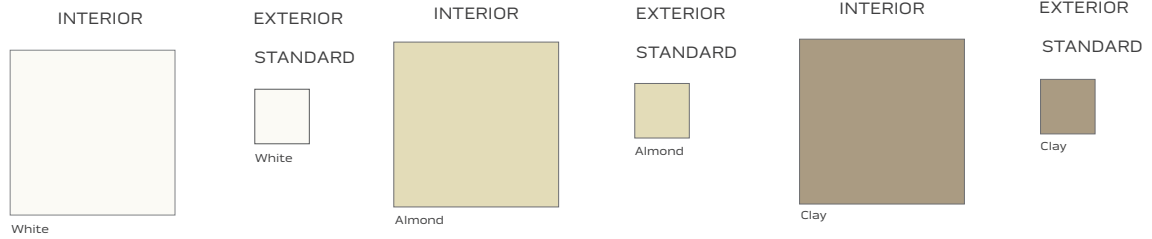

Envision Color Options & Upgrades

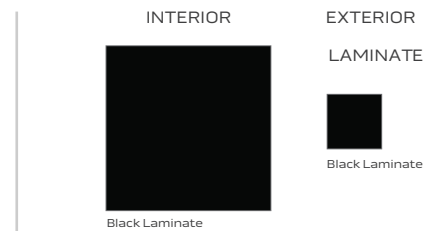

Advantage Series



Advantage Series

Our Advantage Series is designed for performance. When you need windows & doors that will get the job done and look great doing it, look no further. Advantage Series products offer a $2^{1\frac{1}{16}}$ " frame depth, perfect for new construction applications. These windows & doors are fusion welded and hand-finished by our professional craftsmen to exceed your expectations. Unlike many "builder-grade" product lines, we didn't cut any corners with our Advantage Series products. We use the highest quality materials available, creating a value-packed product line to meet your needs.

Advantage Glider Windows

A-GL



Advantage Glider windows offer a sophisticated look. Advantage gliders are the answer for builders caught between style, performance and cost. Our unique design brings the flexibility of radius tops and transoms to a popular window.

The Right Fit

Available in double or triple-sash configurations to meet your unique needs. Advantage Gliders are also available in end-vent or center-vent configurations.



Smooth Operation

Self-cleaning brass carriage rollers will smoothly perform beyond expectations for years to come.



Efficient & Functional

The integrated full-perimeter nailing fin and pile weatherstrip ensure a strong seal to reduce drafts and leaks. The sash can be removed for easy cleaning.



Advantage Single-Hung Windows

A-SH



Advantage Single-Hung windows are a popular standard, built to last a lifetime. With their heavy-duty block and tackle system, these windows open and close with ease. They come in a wide range of sizes and configurations and can be combined with geometric shapes and radius units to create a custom look to fit any home.

Fusion-Welding

All Vector windows have a fusion-welded main frame and sash for enhanced performance and durability.



Easy Operation

Block and tackle balances provides extra lift assistance for easy operation, while the removable sash makes cleaning easier.



Strong Seal

The integrated full-perimeter nailing fin and pile weatherstrip ensure a weathertight seal to reduce drafts and protect against leaks.



Envision Series



Envision Series

Sometimes life calls for an upgrade. Our Envision Series windows clearly stand above the competition. This robust product line features fusion-welded frame & sash panels.

Envision Series windows feature a full 3 $\frac{1}{4}$ " frame depth, with an enhanced architectural profile on the exterior. Equipped with more finishes and accessories—including our fully-welded brickmould system, bronze laminate exterior and light or dark oak woodgrain laminate interiors they'll always make you look good.

Envision Series

Take a closer look at the new window system that is designed to meet the criteria for ENERGY STAR® 6.0 ratings that went into effect in 2016. Better yet, it meets the new standards without costly upgrades.

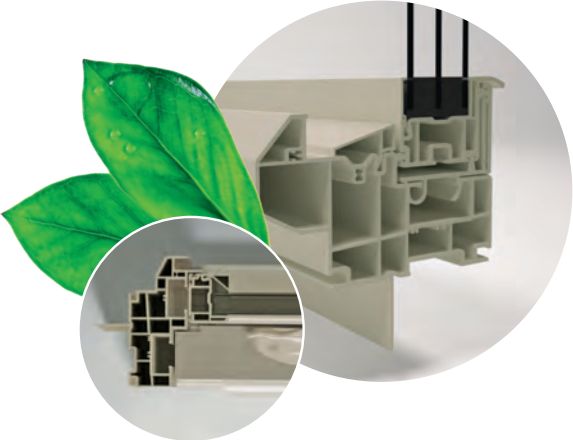

Envision Casement Windows



Envision Casement and Awning windows come in a wide range of sizes and configurations and can be complemented with geometric and radius shapes. The continuous main frame design gives these windows simple beauty you can take pride in.

NVC



Continuous Head & Sill

Envision Casement and Awning windows have a continuous head and sill on multiple wide units up to eight feet wide. This provides clean sight lines, and ensures there's more visible glass to enjoy.

Easy Operation & Cleaning

Smooth operating hinges permit our casement windows to open a full 90 degrees for full ventilation. Our "washability" hinges are designed so the sash will pivot in towards the center of the window, allowing easy cleaning from the inside of the home.

Egress Hardware

Optional egress hardware is available to allow more sizes to meet egress codes.

Security & Design

The multi-point locking hardware system ensures peace of mind, while stylish folding handles eliminate interference with blinds.

Ultimate Energy Efficiency

Want to achieve the ultimate in energy savings? Our Envision Casement and Awning windows are available with triple-pane glass.



Envision Single-Hung Windows



Envision Single-Hung windows offer hassle free operation, low maintenance and traditional styling. With their constant force balance system, these windows open and close with ease. Give your home a distinctive look by combining with picture windows and specialty shapes.



NVH

Performance

Telescoping welded sill detail improves performance and structural rigidity. Our high-performance sloped sills are made from a single extrusion, which makes them stronger and more durable. Multi-chambered extrusions and storm interlock improve energy efficiency and structural performance.

Easy Operation

Constant force balances provides extra lift assistance for easy operation, while our tilt latches allow the bottom sash to tilt in for easy cleaning from the inside.

Strong Seal

The integrated full-perimeter nailing fin and triple weather seal ensure a weathertight seal to reduce drafts and protect against leaks.

Continuous Head & Sill

Envision Single-Hung windows have a continuous head and sill on multiple wide units up to eight feet wide. This provides clean sight lines, and ensures there's more visible glass to enjoy.

Ultimate Energy Efficiency

Want to achieve the ultimate in energy savings? Our Envision Single-Hung windows are available with triple-pane glass.



Envision Double-Hung Windows



Envision Series Double-Hung windows provide the beauty of hassle-free operation, low maintenance and traditional styling. Both sashes open and close with ease and tilt in for effortless cleaning. Give any home a distinctive look by combining these with picture windows and specialty shapes.



NVDH

Performance

Telescoping welded sill detail improves performance and structural rigidity. Our high-performance sloped sills are made from a single extrusion, which makes them stronger and more durable. Multi-chambered extrusions and storm interlock improve energy efficiency and structural performance.

Easy Operation

Constant force balances provide extra lift assistance for easy operation, while our tilt latches allow both sashes to tilt in for easy cleaning from the inside.

Strong Seal

The integrated full-perimeter nailing fin and triple weather seal ensure a weathertight seal to reduce drafts and protect against leaks.

Continuous Head & Sill

Envision Double-Hung windows have a continuous head and sill on multiple wide units up to eight feet wide. This provides clean sight lines, and ensures there's more visible glass to enjoy.

Full Screens

Open both the top and bottom sashes to allow for ventilation, while still keeping bugs out with full screens, which come standard on Envision Double Hung windows.

Ultimate Energy Efficiency

Want to achieve the ultimate in energy savings? Our Envision Double-Hung windows are available with triple-pane glass.



Envision Glider Windows



Envision Glider windows offer a bold, traditional look, while heavy-duty construction and design deliver exceptional performance ratings. Our unique design brings the flexibility of radius tops, transoms to a popular.



The Right Fit

Envision Gliders are available in standard single vent, double vent and end-vent configurations.

Smooth Operation

Anti friction polymer sweep that continuously cleans the track and lets the window slide smoothly and quietly.

Strong Seal

The integrated full-perimeter nailing fin and triple weather seal ensures a strong seal to reduce drafts and leaks. The sash can be removed for easy cleaning.

Concealed Hardware

Sash locks are discreetly hidden from sight, ensuring an uninterrupted view of your surroundings.

Ultimate Energy Efficiency

Want to achieve the ultimate in energy savings? Our Envision Glider windows are available with triple-pane glass.

Double Glider

With Envision Double Gliders, both sashes are fully operational, providing the most flexibility.

NVG



A-SP



Give any home a custom look. At Vector, we can design specialty windows to your exact specifications. Use any of our non-standard shapes as single units, or combine them with any of our standard window systems.

Advantage & Envision Series

Extension Jambs & Casing

Optional extension jambs and casings help you customize any home. We can provide extension jambs and casing to match even arched or other special window shapes.

Custom Sizes

All shapes are available in almost any custom size you need allowing you to create a truly unique design.

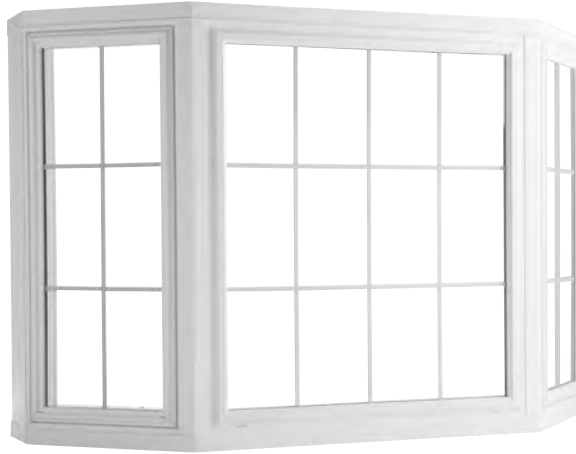

Bay and Bow windows increase the flow of natural light into a home and provide a view of the outside that is unavailable with an ordinary window. Bay and Bow windows can be designed with a number of windows, angles and finish options to suit any style.

Wide View

Envision Bay & Bow windows have a minimum width of 48" and a maximum width of 144". Combine fixed picture windows with operating units to create a truly customized design.

Product Options

Bay and Bow windows are made with Envision Casement, Single Hung and Double Hung windows. Standard configurations provide venting units on each end, with fixed units in the middle, but they have the ability to be customized to the configuration of your choice.

NVBW

Full View Patio Doors



Full View Sliding patio doors incorporate enhanced performance and ease of installation in a door system that has all the flexibility needed for today's design trends. This door meets ENERGY STAR requirements for high performance and compliments either style of windows you choose.

Welded Frame & Sash

The fully-welded frame and sash provide extra strength & performance. Mechanically fastened patio doors have a less-than-perfect track record, so we weld every corner to ensure lasting performance.



Rolling Insect Screen

Let the refreshing breeze blow in while keeping the bugs out with our rolling insect screen. Each door comes standard with a heavy-duty extruded screen that has steel wheels for superior durability.











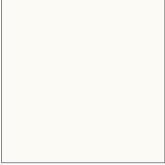

























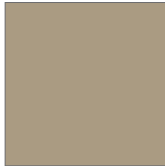



Hardware Options

Full View Sliding patio door handles come in White, Almond, Clay, Black and can be ordered with an optional keyed lock set.

Full View Sliding Patio Doors

Full View Sliding Patio Doors Color Options & Upgrades

<p>INTERIOR</p>  <p>White</p>  <p>Light Oak Laminates</p>  <p>Dark Oak Laminates</p>	<p>EXTERIOR</p> <p>STANDARD</p>  <p>White</p> <p>LAMINATE</p>  <p>Bronze</p>  <p>Black</p> <p>PAINTED</p>  <p>Almond</p>  <p>Clay</p>  <p>Terratone</p>  <p>Bronze</p>  <p>Brick Red</p>  <p>Hunter Green</p>  <p>Cocoa</p>  <p>Black</p>  <p>Custom</p>	<p>INTERIOR</p>  <p>Almond</p>	<p>EXTERIOR</p> <p>STANDARD</p>  <p>Almond</p> <p>PAINTED</p>  <p>Clay</p>  <p>Terratone</p>  <p>Bronze</p>  <p>Black</p>  <p>Brick Red</p>  <p>Hunter Green</p>  <p>Cocoa</p>  <p>Custom</p>	<p>INTERIOR</p>  <p>Black Laminates</p>	<p>EXTERIOR</p> <p>LAMINATE</p>  <p>Black Laminates</p>
<p>INTERIOR</p>  <p>Clay</p>  <p>Light Oak Laminates</p>  <p>Dark Oak Laminates</p>	<p>EXTERIOR</p> <p>STANDARD</p>  <p>Clay</p> <p>PAINTED</p>  <p>Almond</p>  <p>Terratone</p>  <p>Bronze</p>  <p>Black</p>  <p>Brick Red</p>  <p>Hunter Green</p>  <p>Cocoa</p>  <p>Custom</p>				



Single-Point Lock



Dual-Point Lock



Standard Hardware Shown

Keyed Hardware
Option Available

French Sliding Patio Doors



French Sliding patio doors give the appearance of a traditional swinging french door with wider styles and adjustable multipoint lock system. This elegant door meets ENERGY STAR requirements and compliments either style of windows you choose.



Sophisticated Look

French Sliding patio doors add a bold architectural look to any home with their wide sash panels. Optional sidelights and transoms are available to enhance the look.













Beautiful Hardware

Multiple hardware options are available to improve the beauty of any home. Choose the option that fits the best from white, almond, clay, satin nickel, antique brass and oil rubbed bronze.

Blinds Between Glass

White blinds are offered between the glass in the French Sliding patio door with a rough opening of 72" x 80 1/4".

Color Options & Upgrades

<p>INTERIOR</p>  <p>White</p>	<p>EXTERIOR</p> <p>STANDARD</p>  <p>White</p> <p>PAINTED</p> <table border="0"> <tr> <td> Almond</td> <td> Clay</td> <td> Terratone</td> <td> Bronze</td> </tr> <tr> <td> Brick Red</td> <td> Hunter Green</td> <td> Cocoa</td> <td> Black</td> <td> Custom</td> </tr> </table>	 Almond	 Clay	 Terratone	 Bronze	 Brick Red	 Hunter Green	 Cocoa	 Black	 Custom
 Almond	 Clay	 Terratone	 Bronze							
 Brick Red	 Hunter Green	 Cocoa	 Black	 Custom						
<p>INTERIOR</p>  <p>Almond</p>	<p>EXTERIOR</p> <p>STANDARD</p>  <p>Almond</p> <p>PAINTED</p> <table border="0"> <tr> <td> Clay</td> <td> Terratone</td> <td> Bronze</td> <td> Black</td> </tr> <tr> <td> Brick Red</td> <td> Hunter Green</td> <td> Cocoa</td> <td> Custom</td> </tr> </table>	 Clay	 Terratone	 Bronze	 Black	 Brick Red	 Hunter Green	 Cocoa	 Custom	
 Clay	 Terratone	 Bronze	 Black							
 Brick Red	 Hunter Green	 Cocoa	 Custom							
<p>INTERIOR</p>  <p>Clay</p>	<p>EXTERIOR</p> <p>STANDARD</p>  <p>Clay</p> <p>PAINTED</p> <table border="0"> <tr> <td> Almond</td> <td> Terratone</td> <td> Bronze</td> <td> Black</td> </tr> <tr> <td> Brick Red</td> <td> Hunter Green</td> <td> Cocoa</td> <td> Custom</td> </tr> </table>	 Almond	 Terratone	 Bronze	 Black	 Brick Red	 Hunter Green	 Cocoa	 Custom	
 Almond	 Terratone	 Bronze	 Black							
 Brick Red	 Hunter Green	 Cocoa	 Custom							



Dual-Point Lock

French Sliding Door Hardware

French sliding door hardware is available in many different finishes to complement any home.

					
White	Almond	Clay	Antique Brass	Oil Rubbed Bronze	Satin Nickel



High Efficiency Comes Standard.

For more information on energy efficiency and sustainable building, visit EnergyStar.gov & SustainableEnergyCoalition.org.

Beyond Lower Costs

The LoE coating on every pane of glass in Vector windows & doors helps to protect interiors from sun damage by blocking harmful ultraviolet rays, without noticeably reducing visible light. Our windows & doors also deliver more comfort and create less condensation than conventional alternatives.

Traditional metal spacers conduct heat and cold, which causes condensation at the edge of the glass. This condensation is unsightly, and can contribute to unhealthy mold growth. A warmer edge all the way around will strike at the heart of the problem. Vector windows & doors use an industry-leading, Duralite polycarbonate spacer which helps reduce condensation and allows for more comfortable household humidity levels.

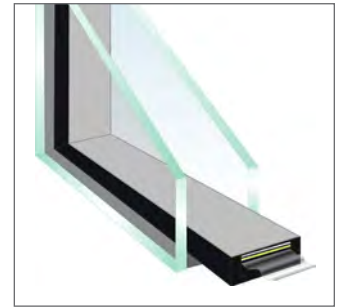

We use an industry-leading, Duralite polycarbonate spacer to dramatically reduce condensation at the edge of the glass.

Green Throughout

At Vector, we're committed to conservation and protecting our environment. Because of their energy efficiency, homes with our windows & doors don't require as much electricity to heat and cool, which decreases unnecessary carbon emissions. We've also taken a number of steps to reduce the waste expended to create them. The material scrap generated by our manufacturing operations is recycled or reused. This includes all of the major components of our products—glass, vinyl, and metal. In addition, our saws and glass cutter utilize optimization software to greatly reduce the amount of material waste generated.

We have worked to make our factory as green as possible. To this end, we've installed high-efficiency lighting and programmable thermostats, and we've optimized the layout of our equipment to significantly cut our energy usage. Moreover, our production facility does not create any emissions that are harmful to the environment.

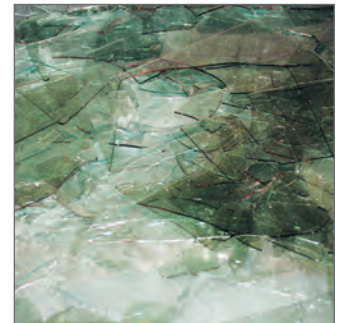

We recycle or reuse all of the scrap generated by our manufacturing operations, including glass.

Money Saving Efficiency

Our standard double-pane, LoE coated, double-strength glass can dramatically reduce window heat loss, because the interior glass stays warmer in cold temperatures, protecting homes from the chill of winter. In the summer, the windows transfer less heat, because the sun is filtered and reflected back outdoors. That means lower energy costs, no matter the climate.

Specifications

<u>How to Spec Vector Products</u>	29 – 30
<u>Advantage Single Hung</u>	31 – 33
<u>Advantage Gliders</u>	34 – 37
<u>Advantage Picture Windows</u>	38 – 42
<u>Advantage Special Shapes</u>	43
<u>Envision Casements & Awnings</u>	44 – 52
<u>Envision Single Hung</u>	53 – 54
<u>Envision Double Hung</u>	55 – 56
<u>Envision Gliders</u>	57 – 60
<u>Envision Picture Windows</u>	61 – 64
<u>Envision Special Shapes</u>	65
<u>Envision Bays & Bows</u>	66
<u>Full View Sliding Patio Doors</u>	67 – 68
<u>French Sliding Patio Doors</u>	69 – 70
<u>Test Performance Data</u>	71 – 73

A-SH

A-GL

A-PW

A-SP

NVC

NVH

NVDH

NVG

NVPW

NVSP

NVBW

FVPD

FSD

Vector products are easy to order and work with. This guide will help you determine precisely which products to order for your particular job. To find a dealer or if you have any questions about our windows and doors, visit us online at VectorWindows.com.

Calculating Openings

The window call-outs in this guide represent the rough opening (R.O.). All standard sized catalog units are sized every six inches. For example: a 2030 unit has a rough opening of two feet wide by three feet tall. A 2636 unit has a rough opening of two feet six inches wide by three feet six inches high. Width is always first, followed by the height. The actual unit dimension is always ½" less than the rough opening. Custom size windows and patio doors are also available.

Lead Times

You don't have time to wait around, not knowing when your windows and doors will arrive. That's why all of our standard products—including custom sizes—are available in two weeks or less. When time is money, can you afford to waste yours?

Egress Calculations

The 1997 Uniform Building Code has established residential egress requirements for windows in sleeping rooms. All egress or rescue windows must meet each of the following:

- Minimum of 5.7 square feet of net clear opening.
- Minimum of 24 inches of net clear height.
- Minimum of 20 inches of net clear width.
- Finished sill height of 44 inches or less above the finished floor.

All Vector products that meet this requirement are marked with an E following the size. An asterisk (*) will be added to windows that meet egress with optional hardware. **Note:** An opening of minimum width by minimum height does not meet the minimum required for net clear opening. Please verify local building codes which may require larger egress openings on your project. These calculations are intended as a guide. Vector assumes no liability in meeting local building codes.

Operating Vs. Stationary

To specify which sash is operating and which is stationary, always start from left to right as you would see the window or door from the exterior of the home. **X** denotes the operating panels while **O** denotes the fixed panel. For example, an **XOX** gliding window or sliding door would have the left and right panels operating as you look at it from outside the home.

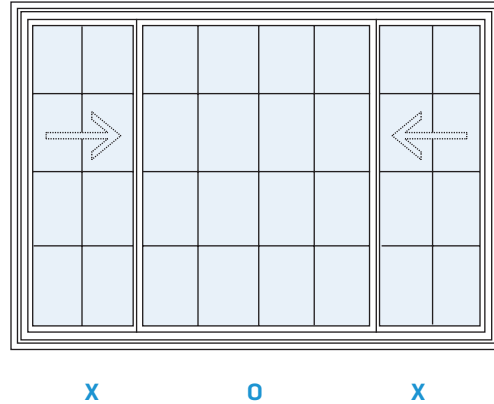

Left vs. Right Handing

For casement windows and patio doors you can specify either left or right handing. Look from the exterior of the home and determine which side of the window or door you would like the hinges to be on. This will determine whether you should specify left or right handing.

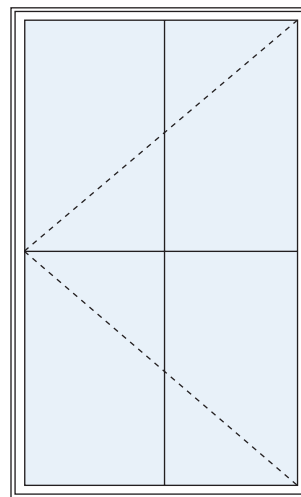

The narrow end of the arrow indicates the position of the hinge.
This illustration represents a left handing window.

Advantage Single Hung Windows

A-SH

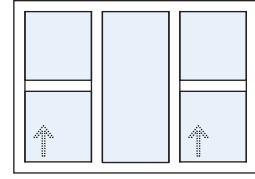
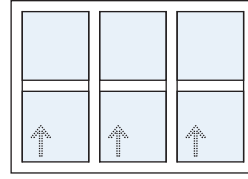
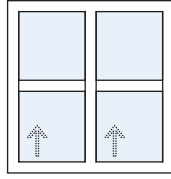
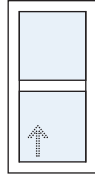

Common Frame

Common Frame

Common Frame

	H1		H2		H3		H3HPH	
	Min	Max	Min	Max	Min	Max	Min	Max
W	13.5"	47.5"	35.5"	83.5"	53.5"	107.5"	53.5"	107.5"
H	25.5"	77.5"	25.5"	77.5"	25.5"	77.5"	25.5"	77.5"

Add-On Jamb Dimensions

Wall Thickness	6 ⁹ / ₁₆ "	6 ¹³ / ₁₆ "
Jamb Size	5 ⁵ / ₁₆ "	5 ⁹ / ₁₆ "

Profile Measurements

Overall Frame Size	2 ¹ / ₁₆ "
Nail Fin Outboard	1 ⁷ / ₁₆ "
Nail Fin Inboard	1 ¹ / ₄ "
Nail Fin Width	1 ¹ / ₁₆ "

Daylight Openings

	W	1'6"	2'0"	2'6"	3'0"	3'6"	4'0"
H	Advantage Single Hung (H1)						
2'6"	2.05	2.99	3.94	4.89	5.83	6.78	
3'0"	2.53	3.78	4.98	6.18	7.37	8.57	
3'6"	3.13	4.57	6.02	7.47	8.91	10.36	
4'0"	3.67	5.36	7.06	8.76	10.46	12.15	
4'6"	4.21	6.16	8.10	10.05	12.00	13.94	
5'0"	4.75	6.95	9.14	11.34	13.54	15.73	
5'6"	5.29	7.74	10.18	12.63	15.08	17.52	
6'0"	5.83	8.53	11.22	13.92	16.62	19.31	

Advantage Single Hung Windows







A-SH

	Unit Dimensions	1'5½"	1'11½"	2'5½"	2'11½"	3'5½"	3'11½"
	Rough Opening	1'6"	2'0"	2'6"	3'0"	3'6"	4'0"
	Operating Glass	12⅞"	18⅞"	24⅞"	30⅞"	36⅞"	42⅞"
2'5½"	H1 ADVANTAGE SINGLE HUNG						
2'6"		1626	2026	2626	3026	3626	4026
2'11½"							
2'6"		1630	2030	2630	3030	3630	4030
3'5½"							
3'6"		1636	2036	2636	3036	3636	4036
3'11½"							
4'0"		1640	2040	2640	3040	3640	4040
4'5½"							
4'6"		1646	2046	2646	3046	3646E	4046E
4'11½"							
5'0"		1650	2050	2650	3050E	3650E	4050E
5'5½"							
5'6"		1656	2056	2656	3056E	3656E	4056E
5'11½"							
6'0"		1660	2060	2660E	3060E	3660E	4060E
32⅜"							

E: Denotes a unit that meets Egress.

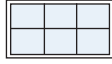
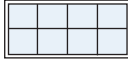
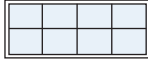
Advantage Single Hung Windows

A-SH

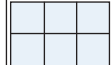
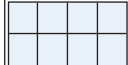
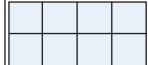
	Unit Dimensions	1'5½"	1'11½"	2'5½"	2'11½"	3'5½"	3'11½"
	Rough Opening	1'6"	2'0"	2'6"	3'0"	3'6"	4'0"
	Glass Size	15¾"	21¾"	27¾"	33¾"	39¾"	45¾"
1'5½"	APWH ADVANTAGE PICTURE WINDOW						
1'6"		1616	2016	2616	3016	3616	4016
1'5½"							
1'11½"		1620	2020	2620	3020	3620	4020
2'0"							
2'1¾"							

Advantage Glider Windows

A-GL

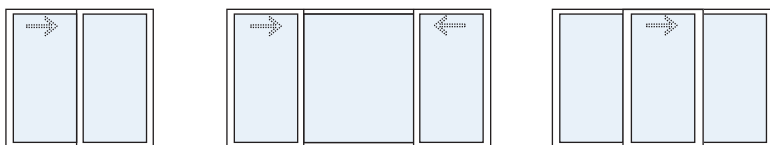

	G1		GE		GC	
	Min	Max	Min	Max	Min	Max
W	25.5"	71.5"	59.5"	95.5"	59.5"	95.5"
H	13.5"	72"	13.5"	59.5"	13.5"	59.5"

Add-On Jamb Dimensions

Wall Thickness	6 ⁹ / ₁₆ "	6 ¹³ / ₁₆ "
Jamb Size	5 ⁵ / ₁₆ "	5 ⁹ / ₁₆ "

Profile Measurements

Overall Frame Size	2 ¹ / ₁₆ "
Nail Fin Outboard	1 ⁷ / ₁₆ "
Nail Fin Inboard	1 ¹ / ₄ "
Nail Fin Width	1 ¹ / ₁₆ "

Daylight Openings

	W	2'6"	3'0"	3'6"	4'0"	4'6"	5'0"	5'6"	6'0"	6'6"	7'0"	7'6"	8'0"
H	Advantage Glider (G1)												
2'0"		2.77	3.69	4.48	5.27	6.06	6.85	7.64	8.43				
2'6"		3.81	4.86	5.90	6.94	7.98	9.02	10.06	11.10				
3'0"		4.86	6.02	7.31	8.60	9.89	11.18	12.47	13.76				
3'6"		5.90	7.19	8.73	10.27	11.81	13.35	14.89	16.43				
4'0"		6.94	8.36	10.15	11.94	13.73	15.52	17.31	19.10				
4'6"		7.98	9.52	11.56	13.60	15.64	17.68	19.72	21.76				
5'0"		9.02	10.69	12.98	15.27	17.56	19.85	22.14	24.43				
	Advantage End Vent (GE)												
2'6"									9.96	10.97	11.97	12.97	13.97
3'0"									12.45	13.70	14.95	16.21	17.46
3'6"									14.93	16.43	17.94	19.44	20.94
4'0"									17.42	19.17	20.92	22.67	24.43
4'6"									19.90	21.90	23.91	25.91	27.91
5'0"									22.39	24.64	26.89	29.14	31.40
	Advantage Center Vent (GC)												
2'6"									11.15	12.23	13.32	14.40	15.48
3'0"									13.72	15.06	16.39	17.72	19.06
3'6"									16.30	17.88	19.46	21.05	22.63
4'0"									18.87	20.70	22.53	24.37	26.20
4'6"									21.44	23.52	25.61	27.69	29.77
5'0"									24.01	26.35	28.68	31.01	33.35

Advantage Glider Windows











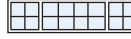



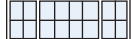
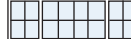



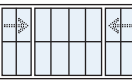
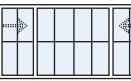
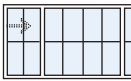
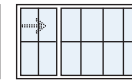

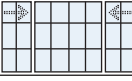
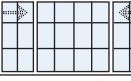
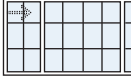
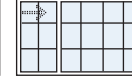
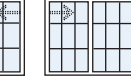
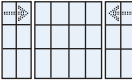
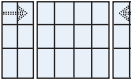
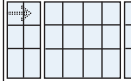
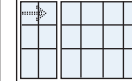
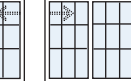
A-GL

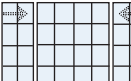
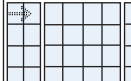
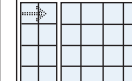
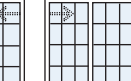
		Unit Dimensions	2'5½"	2'11½"	3'5½"	3'11½"	4'5½"	4'11½"	5'5½"	5'11½"
1'5½"	1'6"	Rough Opening	2'6"	3'0"	3'6"	4'0"	4'6"	5'0"	5'6"	6'0"
	15¾"	Glass Size	27¾"	33¾"	39¾"	45¾"	51¾"	57¾"	63¾"	69¾"
		APWG ADVANTAGE PICTURE WINDOWS								
			2616	3016	3616	4016	4616	5016	5616	6016
1'11½"	2'0"	Rough Opening	2'6"	3'0"	3'6"	4'0"	4'6"	5'0"	5'6"	6'0"
	21¾"	Glass Size	27¾"	33¾"	39¾"	45¾"	51¾"	57¾"	63¾"	69¾"
		APWG ADVANTAGE PICTURE WINDOWS								
			2620	3020	3620	4020	4620	5020	5620	6020
		Unit Dimensions	2'5½"	2'11½"	3'5½"	3'11½"	4'5½"	4'11½"	5'5½"	5'11½"
1'11½"	2'0"	Rough Opening	2'6"	3'0"	3'6"	4'0"	4'6"	5'0"	5'6"	6'0"
	18⅞"	Operating Glass	11⅛"	14⅛"	17⅛"	20⅛"	23⅛"	26⅛"	29⅛"	32⅛"
		G1 ADVANTAGE GLIDER								
			2620	3020	3620	4020	4620	5020	5620	6020
2'5½"	2'6"	Rough Opening	2'6"	3'0"	3'6"	4'0"	4'6"	5'0"	5'6"	6'0"
	24⅞"	Operating Glass	11⅛"	14⅛"	17⅛"	20⅛"	23⅛"	26⅛"	29⅛"	32⅛"
		G1 ADVANTAGE GLIDER								
			2626	3026	3626	4026	4626	5026	5626	6026
2'11½"	3'0"	Rough Opening	2'6"	3'0"	3'6"	4'0"	4'6"	5'0"	5'6"	6'0"
	30⅞"	Operating Glass	11⅛"	14⅛"	17⅛"	20⅛"	23⅛"	26⅛"	29⅛"	32⅛"
		G1 ADVANTAGE GLIDER								
			2630	3030	3630	4030	4630	5030E	5630E	6030E
3'5½"	3'6"	Rough Opening	2'6"	3'0"	3'6"	4'0"	4'6"	5'0"	5'6"	6'0"
	36⅞"	Operating Glass	11⅛"	14⅛"	17⅛"	20⅛"	23⅛"	26⅛"	29⅛"	32⅛"
		G1 ADVANTAGE GLIDER								
			2636	3036	3636	4036	4636E	5036E	5636E	6036E
3'11½"	4'0"	Rough Opening	2'6"	3'0"	3'6"	4'0"	4'6"	5'0"	5'6"	6'0"
	42⅞"	Operating Glass	11⅛"	14⅛"	17⅛"	20⅛"	23⅛"	26⅛"	29⅛"	32⅛"
		G1 ADVANTAGE GLIDER								
			3040	3640	4040E	4640E	5040E	5640E	6040E	
4'5½"	4'6"	Rough Opening	2'6"	3'0"	3'6"	4'0"	4'6"	5'0"	5'6"	6'0"
	48⅞"	Operating Glass	11⅛"	14⅛"	17⅛"	20⅛"	23⅛"	26⅛"	29⅛"	32⅛"
		G1 ADVANTAGE GLIDER								
			3046	3646	4046E	4646E	5046E	5646E	6046E	
4'11½"	5'0"	Rough Opening	2'6"	3'0"	3'6"	4'0"	4'6"	5'0"	5'6"	6'0"
	54⅞"	Operating Glass	11⅛"	14⅛"	17⅛"	20⅛"	23⅛"	26⅛"	29⅛"	32⅛"
		G1 ADVANTAGE GLIDER								
			3050	3650	4050E	4650E	5050E	5650E	6050E	

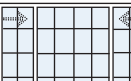
E: Denotes a unit that meets Egress.

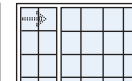
Advantage Glider Windows

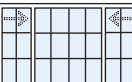
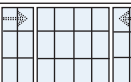
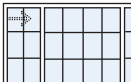
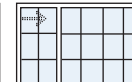

A-GL

		Unit Dimensions	5'11½"	6'5½"	6'11½"	7'5½"	7'11½"
		Rough Opening	6'0"	6'6"	7'0"	7'6"	8'0"
		Glass Size	22"	24"	26"	28"	30"
1'5½"	1'6"	APW3 ADVANTAGE PICTURE WINDOW					
			6016	6616	7016	7616	8016
1'11½"	2'0"						
	2'13⁄8"		6020	6620	7020	7620	8020
		Unit Dimensions	5'11½"	6'5½"	6'11½"	7'5½"	7'11½"
		Rough Opening	6'0"	6'6"	7'0"	7'6"	8'0"
		Operating Glass	14½⁄16"	15⁹⁄16"	17½⁄16"	18⁹⁄16"	20½⁄16"
2'5½"	2'6"	GE ADVANTAGE GLIDER END VENT					
	2'11½"		6026	6626	7026	7626	8026
3'0"	3'0"						
	3'6"		6030	6630	7030	7630	8030
3'5½"	3'6"						
	3'11½"		6036	6636	7036	7636	8036
4'0"	4'0"						
	4'5½"		6040	6640	7040	7640	8040E
4'5½"	4'6"						
	4'11½"		6046	6646	7046	7646	8046E
5'0"	5'0"						
	5'4⁹⁄16"		6050	6650	7050	7650	8050E

E: Denotes a unit that meets Egress.

Advantage Glider Windows

A-GL

		Unit Dimensions	5'11½"	6'5½"	6'11½"	7'5½"	7'11½"
		Rough Opening	6'0"	6'6"	7'0"	7'6"	8'0"
		Glass Size	22"	24"	26"	28"	30"
1'5½"	1'6"	APW3 ADVANTAGE PICTURE WINDOW					
	15¾"		6016	6616	7016	7616	8016
1'11½"	2'0"						
	21¾"		6020	6620	7020	7620	8020
		Unit Dimensions	5'11½"	6'5½"	6'11½"	7'5½"	7'11½"
		Rough Opening	6'0"	6'6"	7'0"	7'6"	8'0"
		Operating Glass	20¾"	22¾"	24¾"	26¾"	28¾"
2'5½"	2'6"	GC ADVANTAGE GLIDER CENTER VENT					
	24¾"		6026	6626	7026	7626	8026
2'11½"	3'0"						
	30¾"		6030	6630	7030	7630	8030E
3'5½"	3'6"						
	36¾"		6036	6636E	7036E	7636E	8036E
3'11½"	4'0"						
	42¾"		6040E	6640E	7040E	7640E	8040E
4'5½"	4'6"						
	48¾"		6046E	6646E	7046E	7646E	8046E
4'11½"	5'0"						
	54¾"		6050E	6650E	7050E	7650E	8050E

E: Denotes a unit that meets Egress.

Advantage Picture Windows

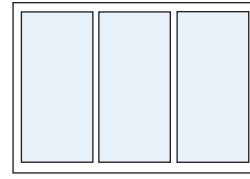
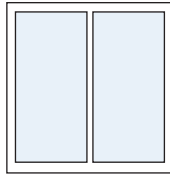
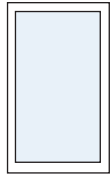

Common Frame

Common Frame

A-PW

	APWH, APWG		APW2		APW3	
	Min	Max	Min	Max	Min	Max
W	11.5"	71.5"	23.5"	83.5"	35.5"	107.5"
H	11.5"	77.5"	11.5"	77.5"	11.5"	77.5"

Add-On Jamb Dimensions

Wall Thickness	6 ⁵ / ₁₆ "	6 ¹³ / ₁₆ "
Jamb Size	5 ⁵ / ₁₆ "	5 ⁹ / ₁₆ "

Profile Measurements





































































Overall Frame Size	2 ¹¹ / ₁₆ "
Nail Fin Outboard	1 ⁷ / ₁₆ "
Nail Fin Inboard	1 ¹ / ₄ "
Nail Fin Width	1 ¹ / ₁₆ "

Daylight Openings

	W	1'6"	2'0"	2'6"	3'0"	3'6"	4'0"	4'6"	5'0"	5'6"	6'0"	6'6"	7'0"	7'6"	8'0"
H	Advantage Picture Window (APW)														
1'6"	1.56	2.19	2.81	3.44	4.06	4.69	5.31	5.94	6.55	7.19	7.50	8.11	8.71	9.31	
2'0"	2.19	3.06	3.94	4.81	5.69	6.56	7.44	8.31	9.19	10.06	10.61	11.46	12.31	13.71	
2'6"	2.81	3.94	5.06	6.19	7.31	8.44	9.56	10.69	11.61	12.94	13.71	14.86	15.92	17.02	
3'0"	3.44	4.81	6.19	7.56	8.94	10.31	11.69	13.06	14.44	15.81	16.81	18.17	19.52	20.88	
3'6"	4.06	5.69	7.31	8.94	10.56	12.19	13.81	15.44	17.06	18.69	19.92	21.52	23.13	24.73	
4'0"	4.69	6.56	8.44	10.31	12.19	14.06	15.94	17.81	19.69	21.56	23.02	24.88	26.73	28.59	
4'6"	5.31	7.44	9.56	11.9	13.81	15.94	18.06	20.19	22.31	24.44	26.13	28.23	30.34	32.44	
5'0"	5.94	8.31	10.69	13.06	15.44	17.81	20.19	22.56	24.94	27.31	29.23	31.59	33.94	36.29	

Advantage Picture Windows

A-PW

	Unit Dimensions	1'5½"	1'11½"	2'5½"	2'11½"	3'5½"	3'11½"		
	Rough Opening	1'6"	2'0"	2'6"	3'0"	3'6"	4'0"		
	Glass Size	15⅜"	21⅜"	27⅜"	33⅜"	39⅜"	45⅜"		
1'5½"	1'6"	15⅜"	APWH ADVANTAGE PICTURE WINDOW 						
1'11½"	2'0"	21⅜"	(GRIDS MATCH ADVANTAGE SINGLE-HUNG WINDOWS) 						
2'5½"	2'6"	27⅜"							
2'11½"	3'0"	33⅜"							
3'5½"	3'6"	39⅜"							
3'11½"	4'0"	45⅜"							
4'5½"	4'6"	51⅜"							
4'11½"	5'0"	57⅜"							
5'5½"	5'6"	63⅜"							
5'11½"	6'0"	69⅜"							
			1616	2016	2616	3016	3616	4016	
			1620	2020	2620	3020	3620	4020	
			1626	2026	2626	3026	3626	4026	
			1630	2030	2630	3030	3630	4030	
			1636	2036	2636	3036	3636	4036	
			1640	2040	2640	3040	3640	4040	
			1646	2046	2646	3046	3646	4046	
			1650	2050	2650	3050	3650	4050	
			1656	2056	2656	3056	3656	4056	
			1660	2060	2660	3060	3660	4060	

Advantage Picture Windows

	Unit Dimensions	2'5½"	2'11½"	3'5½"	3'11½"	
	Rough Opening	2'6"	3'0"	3'6"	4'0"	
	Glass Size	27⅞"	33⅞"	39⅞"	45⅞"	
1'5½"	1'6"	15⅞"	APWG ADVANTAGE PICTURE WINDOW			
1'11½"	2'0"	21⅞"	(GRIDS MATCH ADVANTAGE GLIDERS)			
2'5½"	2'6"	27⅞"	2616	3016	3616	4016
2'11½"	3'0"	33⅞"	2620	3020	3620	4020
3'5½"	3'6"	39⅞"	2626	3026	3626	4026
3'11½"	4'0"	45⅞"	2630	3030	3630	4030
4'5½"	4'6"	51⅞"	2636	3036	3636	4036
4'11½"	5'0"	57⅞"	2640	3040	3640	4040
5'5½"	5'6"	63⅞"	2646	3046	3646	4046
5'11½"	6'0"	69⅞"	2650	3050	3650	4050
			2656	3056	3656	4056
			2660	3060	3660	4060

A-PW























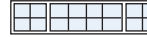

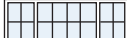
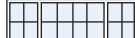
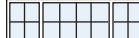
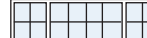
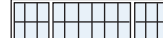
Advantage Picture Windows

A-PW

	Unit Dimensions	4'5½"	4'11½"	5'5½"	5'11½"
	Rough Opening	4'6"	5'0"	5'6"	6'0"
	Glass Size	51⅞"	57⅞"	63⅞"	69⅞"
1'5½"	1'6"	15⅜"	APWG ADVANTAGE PICTURE WINDOW		
		4616	5016	5616	6016
1'11½"	2'0"	21⅜"	(GRIDS MATCH ADVANTAGE GLIDERS)		
		4620	5020	5620	6020
2'5½"	2'6"	27⅜"			
		4626	5026	5626	6026
2'11½"	3'0"	33⅜"			
		4630	5030	5630	6030
3'5½"	3'6"	39⅜"			
		4636	5036	5636	6036
3'11½"	4'0"	45⅜"			
		4640	5040	5640	6040
4'5½"	4'6"	51⅜"			
		4646	5046	5646	6046
4'11½"	5'0"	57⅜"			
		4650	5050	5650	6050
5'5½"	5'6"	63⅜"			
		4656	5056		
5'11½"	6'0"	69⅜"			
		4660	5060		

Advantage Picture Windows

A-PW

		Unit Dimensions	2' 11½"	3' 11½"	4' 11½"	5' 11½"	6' 11½"
		Rough Opening	3' 0"	4' 0"	5' 0"	6' 0"	7' 0"
		Glass Size	16"	22"	28"	34"	40"
1' 5½"	1' 6"	APW2 ADVANTAGE PICTURE WINDOW					
	1' 11½"		3016	4016	5016	6016	7016
1' 11½"	2' 0"						
	2' 13⁄8"		3020	4020	5020	6020	7020
		Unit Dimensions	5' 11½"	6' 5½"	6' 11½"	7' 5½"	7' 11½"
		Rough Opening	6' 0"	6' 6"	7' 0"	7' 6"	8' 0"
		Glass Size	16⅝"	17⅝"	19⅝"	20⅝"	22⅝"
1' 5½"	1' 6"	APW3 ADVANTAGE PICTURE WINDOW					
	1' 11½"		6016	6616	7016	7616	8016
1' 11½"	2' 0"	(GRIDS MATCH ADVANTAGE GLIDER END VENT WINDOWS)					
	2' 13⁄8"		6020	6620	7020	7620	8020
		Unit Dimensions	5' 11½"	6' 5½"	6' 11½"	7' 5½"	7' 11½"
		Rough Opening	6' 0"	6' 6"	7' 0"	7' 6"	8' 0"
		Glass Size	16⅝"	17⅝"	19⅝"	20⅝"	22⅝"
1' 5½"	1' 6"	APW3 ADVANTAGE PICTURE WINDOW					
	1' 11½"		6016	6616	7016	7616	8016
1' 11½"	2' 0"	(GRIDS MATCH ADVANTAGE GLIDER CENTER VENT WINDOWS)					
	2' 13⁄8"		6020	6620	7020	7620	8020

Advantage Special Shapes

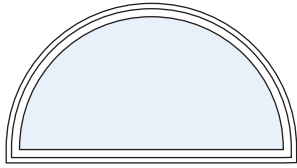

Half Round

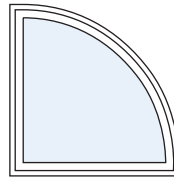

Quarter Round

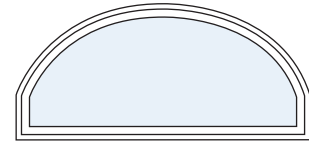

Modified Arch

A-SP

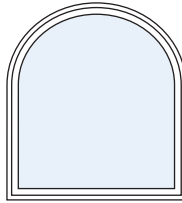

Tall Arch

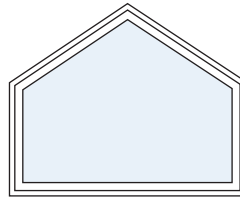

Pentoid

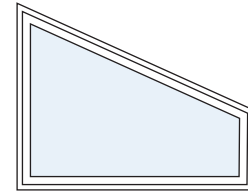

Trapezoid

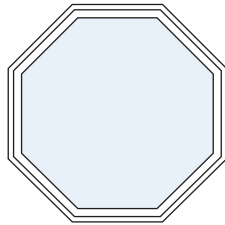

Octagon

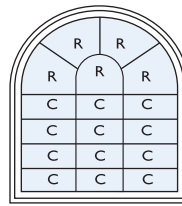

Custom Grille Layouts

Profile Measurements

Overall Frame Size	2 ¹¹ / ₁₆ "
Nail Fin Outboard	1 ⁷ / ₁₆ "
Nail Fin Inboard	1 ¹ / ₄ "
Nail Fin Width	1 ¹ / ₁₆ "

Optional extension jambs and casing available. All shapes available custom sized.

Envision Casements & Awnings

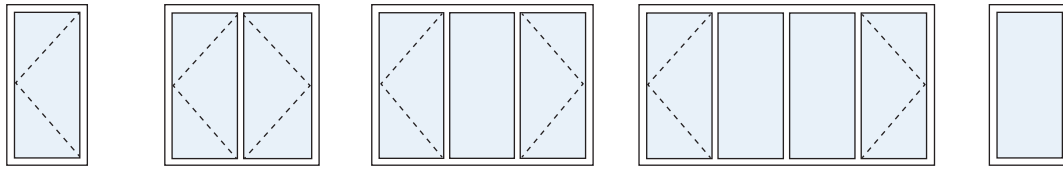

Common Frame

Common Frame

Common Frame

	NVC1		NVC2		NVC3		NVC4		NVFC	
	Min	Max	Min	Max	Min	Max	Min	Max	Min	Max
W	17"	36"	35.5"	72"	53.5"	105"	71.5"	105"	12.5"	96"
H	19.5"	75"	19.5"	75"	19.5"	75"	19.5"	75"	12"	78"

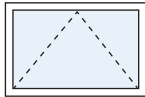

	Min	Max
W	15"	60"
H	17.5"	42"



































NVA1

Daylight Openings

	W	1'6"	2'0"	2'6"	2'8"	3'0"	3'6"	4'0"	5'0"	5'4"	6'0"
H	Envision Casement (NVC1)										
2'6"		2.26	3.30	4.34	4.69	5.38					
3'0"		2.80	4.09	5.38	5.81	6.67					
3'6"		3.34	4.88	6.42	6.94	7.97					
4'0"		3.88	5.67	7.47	8.06	9.26					
4'6"		4.42	6.47	8.51	9.19	10.55					
5'0"		4.97	7.26	9.55	10.31	11.84					
5'6"		5.51	8.05	10.59	11.44	13.13					
6'0"		6.05	8.84	11.63	12.56	14.42					
	Envision Casement Operator Picture (NVCOP)										
2'6"						4.67		6.76	8.84	9.52	10.91
3'0"						5.80		8.38	10.96	11.81	13.53
3'6"						6.92		10.00	13.07	14.11	16.15
4'0"						8.04		11.62	15.19	16.39	18.78
4'6"						9.16		13.25	17.32	18.68	21.40
5'0"						10.29		14.87	19.44	20.97	24.02
5'6"						11.41		16.49	21.56	23.26	26.64
6'0"						12.53		18.11	23.68	25.55	29.27
	Envision Fixed Casement (NVFC)										
2'6"		2.27	3.32	4.36		5.41					
3'0"		2.82	4.11	5.41		6.70					
3'6"		3.36	4.91	6.45		7.99					
4'0"		3.91	5.70	7.49		9.29					
4'6"		4.45	6.49	8.54		10.58					
5'0"		4.99	7.29	9.58		11.88					
5'6"		5.54	8.08	10.63		13.17					
6'0"		6.08	8.88	11.67		14.47					
	Envision Awning (NVA1)										
1'6"			1.72	2.26		2.80	3.34	3.88			
2'0"			2.51	3.30		4.09	4.88	5.67			
2'6"			3.30	4.34		5.38	6.42	7.47			

NVC

Envision Casements & Awnings

	Unit Dimensions	1'5½"	1'11½"	2'5½"	2'7½"	2'11½"
	Rough Opening	1'6"	2'0"	2'6"	2'8"	3'0"
	Operating Glass	13 ¹⁵ / ₁₆ "	19 ¹⁵ / ₁₆ "	25 ¹⁵ / ₁₆ "	27 ¹⁵ / ₁₆ "	31 ¹⁵ / ₁₆ "
2'5½"	NVC1 ENVISION CASEMENT 					
2'6"		1626	2026	2626	2826	3026
2'11½"						
3'0"		1630	2030	2630	2830	3030E*
3'5½"						
3'6"		1636	2036	2636E*	2836E*	3036E
3'11½"						
4'0"		1640	2040	2640E*	2840E	3040E
4'5½"						
4'6"	1646	2046	2646E*	2846E	3046E	
4'11½"						
5'0"	1650	2050	2650E*	2850E	3050E	
5'5½"						
5'6"	1656	2056	2656E*	2856E	3056E	
5'11½"						
6'0"	1660	2060	2660E*	2860E	3060E	

E: Denotes a unit that meets Egress.
E*: These units meet Egress only with added Egress hardware.



Envision Casements & Awnings

	Unit Dimensions	2'11½"	3'11½"	4'11½"	5'3½"	5'11½"	
	Rough Opening	3'0"	4'0"	5'0"	5'4"	6'0"	
	Operating Glass	14 ⁷ / ₁₆ "	20 ⁷ / ₁₆ "	26 ⁷ / ₁₆ "	28 ⁷ / ₁₆ "	32 ⁷ / ₁₆ "	
2'5½"	2'6"	25 ¹⁵ / ₁₆ "	NVC2 ENVISION TWO WIDE CASEMENT				
			3026	4026	5026	5426	6026
2'11½"	3'0"	31 ¹⁵ / ₁₆ "					
			3030	4030	5030	5430	6030E*
3'5½"	3'6"	37 ⁵ / ₁₆ "					
			3036	4036	5036E*	5436E*	6036E
3'11½"	4'0"	43 ¹⁵ / ₁₆ "					
			3040	4040	5040E*	5440E	6040E
4'5½"	4'6"	49 ⁵ / ₁₆ "					
			3046	4046	5046E*	5446E	6046E
4'11½"	5'0"	55 ¹⁵ / ₁₆ "					
			3050	4050	5050E*	5450E	6050E
5'5½"	5'6"	61 ⁵ / ₁₆ "					
			3056	4056	5056E*	5456E	6056E
5'11½"	6'0"	67 ¹⁵ / ₁₆ "					
			3060	4060	5060E*	5460E	6060E



E: Denotes a unit that meets Egress.
E*: These units meet Egress only with added Egress hardware.

Envision Casements & Awnings

NVC

		Unit Dimensions	4'5½"	5'11½"	7'5½"	7'11½"				
		Rough Opening	4'6"	6'0"	7'6"	8'0"				
		Operating Glass	14 ¹¹ / ₁₆ "	20 ¹¹ / ₁₆ "	26 ¹¹ / ₁₆ "	28 ¹¹ / ₁₆ "				
2'5½"	2'6"	25 ¹⁵ / ₁₆ "	NVC3 ENVISION THREE WIDE CASEMENT							
			4626	6026	7626	8026				
			2'11½"	3'0"	31 ¹⁵ / ₁₆ "					
						4630	6030	7630	8030	
			3'5½"	3'6"	37 ¹⁵ / ₁₆ "					
						4636	6036	7636E*	8036E*	
			3'11½"	4'0"	43 ¹⁵ / ₁₆ "					
						4640	6040	7640E*	8040E	
4'5½"	4'6"	49 ¹⁵ / ₁₆ "								
			4646	6046	7646E*	8046E				
4'11½"	5'0"	55 ¹⁵ / ₁₆ "								
			4650	6050	7650E*	8050E				
5'5½"	5'6"	61 ¹⁵ / ₁₆ "								
			4656	6056	7656E*	8056E				
5'11½"	6'0"	67 ¹⁵ / ₁₆ "								
			4660	6060	7660E*	8060E				

E: Denotes a unit that meets Egress.
E*: These units meet Egress only with added Egress hardware.

Envision Casements & Awnings

	Unit Dimensions	5'11½"	7'11½"
	Rough Opening	6'0"	8'0"
	Operating Glass	14 ¹¹ / ₁₆ "	20 ¹¹ / ₁₆ "
2'5½"	2'6"		
		6026	8026
2'11½"	3'0"		
		6030	8030
3'5½"	3'6"		
		6036	8036
3'11½"	4'0"		
		6040	8040
4'5½"	4'6"		
		6046	8046
4'11½"	5'0"		
		6050	8050
5'5½"	5'6"		
		6056	8056
5'11½"	6'0"		
		6060	8060

NVC4
ENVISION
FOUR WIDE
CASEMENT



Envision Casements & Awnings













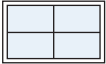

NVC

	Unit Dimensions	2'11½"	3'11½"	4'11½"	5'3½"	5'11½"
	Rough Opening	3'0"	4'0"	5'0"	5'4"	6'0"
	Operating Glass	14 ⁷ / ₁₆ "	20 ⁷ / ₁₆ "	26 ⁷ / ₁₆ "	28 ⁷ / ₁₆ "	32 ⁷ / ₁₆ "
2'5½"	2'6"					
						
		3026	4026	5026	5426	6026
2'11½"	3'0"					
		3030	4030	5030	5430	6030E*
3'5½"	3'6"					
		3036	4036	5036E*	5436E*	6036E
3'11½"	4'0"					
		3040	4040	5040E*	5440E	6040E
4'5½"	4'6"					
		3046	4046	5046E*	5446E	6046E
4'11½"	5'0"					
		3050	4050	5050E*	5450E	6050E
5'5½"	5'6"					
		3056	4056	5056E*	5456E	6056E
5'11½"	6'0"					
		3060	4060	5060E*	5460E	6060E

E: Denotes a unit that meets Egress.

E*: These units meet Egress only with added Egress hardware.

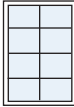

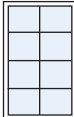
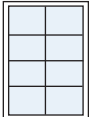
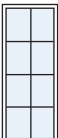
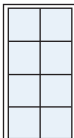
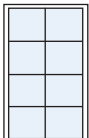
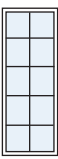
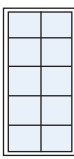
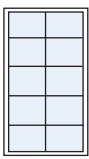











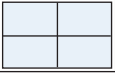
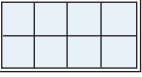



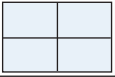
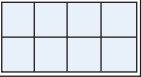
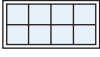

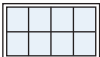
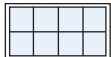
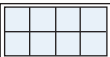
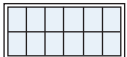
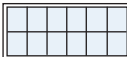
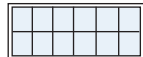

Envision Casements & Awnings

	Unit Dimensions	1'5½"	1'11½"	2'5½"	2'11½"	
	Rough Opening	1'6"	2'0"	2'6"	3'0"	
	Glass Size	14"	20"	26"	32"	
2'5½"	2'6"	26"	NVFC ENVISION FIXED CASEMENT			
						
		1626	2026	2626	3026	
2'11½"	3'0"	32"				
		32"	1630	2030	2630	
		32"	3030	3030	3030	
3'5½"	3'6"	38"				
		38"	1636	2036	2636	
		38"	3036	3036	3036	
3'11½"	4'0"	44"				
		44"	1640	2040	2640	
		44"	3040	3040	3040	
4'5½"	4'6"	50"				
		50"	1646	2046	2646	
		50"	3046	3046	3046	
4'11½"	5'0"	56"				
		56"	1650	2050	2650	
		56"	3050	3050	3050	
5'5½"	5'6"	62"				
		62"	1656	2056	2656	
		62"	3056	3056	3056	
5'11½"	6'0"	68"				
		68"	1660	2060	2660	
		68"	3060	3060	3060	



Envision Casements & Awnings

NVC

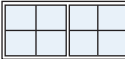
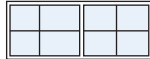
		Unit Dimensions	1'5½"	1'11½"	2'5½"	2'7½"	2'11½"	3'11½"
1'5½"	1'6"	Rough Opening	1'6"	2'0"	2'6"	2'8"	3'0"	4'0"
	14"	Glass Size	14"	20"	26"	28"	32"	44"
1'11½"	2'0"	NVFC ENVISION FIXED CASEMENT (TRANSOM SIZES)						
	14"		1616	2016	2626	2816	3016	4016
1'11½"	2'0"							
	20"		1620	2020	2620	2820	3020	4020
		Unit Dimensions	4'5½"	4'11½"	5'3½"	5'11½"	7'5½"	7'11½"
1'5½"	1'6"	Rough Opening	4'6"	5'0"	5'4"	6'0"	7'6"	8'0"
	14"	Glass Size	50"	56"	60"	68"	86"	92"
1'11½"	2'0"	NVFC ENVISION FIXED CASEMENT (TRANSOM SIZES)						
	14"		4616	5016	5416	6016	7616	8016
1'11½"	2'0"							
	20"		4620	5020	5420	6020	7620	8020
		Unit Dimensions	2'11½"	3'11½"	4'11½"	5'3½"	5'11½"	
1'5½"	1'6"	Rough Opening	3'0"	4'0"	5'0"	5'4"	6'0"	
	13⅞"	Glass Size	14⅜"	20⅜"	26⅜"	28⅜"	32⅜"	
1'11½"	1'6"	NVFC2 ENVISION 2 LITE FIXED CASEMENT						
	13⅞"		3016	4016	5016	5416	6016	
1'11½"	2'0"							
	19⅞"		3020	4020	5020	5420	6020	

Envision Casements & Awnings



		Unit Dimensions	4'5½"	5'11½"	7'5½"	7'11½"	
		Rough Opening	4'6"	6'0"	7'6"	8'0"	
		Glass Size	14⅝"	20⅝"	26⅝"	28⅝"	
1'5½"	1'6"	NVFC3 ENVISION 3 LITE FIXED CASEMENT					
	13⅞"		4616	6016	7616	8016	
1'11½"	2'0"						
	19⅞"		4620	6020	7620	8020	
		Unit Dimensions	5'11½"	7'11½"			
		Rough Opening	6'0"	8'0"			
		Glass Size	14⅝"	20⅝"			
1'5½"	1'6"	NVFC4 ENVISION 4 LITE FIXED CASEMENT					
	13⅞"		6016	8016			
1'11½"	2'0"						
	19⅞"		6020	8020			
		Unit Dimensions	1'11½"	2'5½"	2'11½"	3'5½"	3'11½"
		Rough Opening	2'0"	2'6"	3'0"	3'6"	4'0"
		Operating Glass	19⅛"	25⅛"	31⅛"	37⅛"	43⅛"
1'5½"	1'6"	NVA1 ENVISION AWNING					
	13⅛"		2016	2616	3016	3616	4016
	1'11½"		2'0"				
19⅛"		2020	2620	3020	3620	4020	
2'5½"	2'6"						
	25⅛"		2026	2626	3026	3626	4026

Envision Single Hung Windows

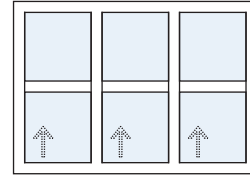
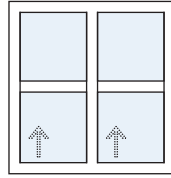
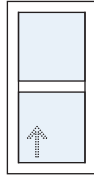

Common Frame

Common Frame

	NVH1		NVH2		NVH3	
	Min	Max	Min	Max	Min	Max
W	17"	52"	35.5"	96"	53.5"	110"
H	27"	84"	27"	78"	27"	78"

NVH

Add-On Jamb Dimensions

Wall Thickness	6 ⁵ / ₁₆ "	6 ¹³ / ₁₆ "
Jamb Size	4 ¹ / ₂ "	4 ³ / ₄ "

Profile Measurements

Overall Frame Size	3 ¹ / ₄ "
Nail Fin Outboard	1 ¹ / ₈ "
Nail Fin Inboard	2 ¹ / ₁₆ "
Nail Fin Width	1 ¹ / ₈ "

Daylight Openings

	W	1'6"	2'0"	2'6"	3'0"	3'6"	4'0"
H	Envision Single Hung (NVH1)						
2'6"		1.91	2.87	3.81	4.75	5.71	6.65
3'0"		2.42	3.62	4.82	6.02	7.22	8.41
3'6"		2.93	4.37	5.82	7.27	8.72	10.17
4'0"		3.43	5.13	6.83	8.53	10.23	11.92
4'6"		3.94	5.88	7.84	9.78	11.72	13.68
5'0"		4.44	6.64	8.84	11.03	13.23	15.43
5'6"		4.95	7.39	9.85	12.29	14.74	17.19
6'0"		5.46	8.15	10.84	13.54	16.24	18.94

Envision Single Hung Windows

		Unit Dimensions						
		1'5½"	1'11½"	2'5½"	2'11½"	3'5½"	3'11½"	
		Rough Opening						
		1'6"	2'0"	2'6"	3'0"	3'6"	4'0"	
		Operating Glass						
		12¾"	18¾"	24¾"	30¾"	36¾"	42¾"	
2'5½"	2'6"							
	12½/16"	1626	2026	2626	3026	3626	4026	
	2'11½"	3'0"						
		15½/16"	1630	2030	2630	3030	3630	4030
	3'5½"	3'6"						
		18¾/16"	1636	2036	2636	3036	3636	4036
	3'11½"	4'0"						
		21½/16"	1640	2040	2640	3040	3640	4040
4'5½"	4'6"							
	24¾/16"	1646	2046	2646	3046	3646	4046	
4'11½"	5'0"							
	27½/16"	1650	2050	2650	3050	3650E	4050E	
5'5½"	5'6"							
	30¾/16"	1656	2056	2656	3056E	3656E	4056E	
5'11½"	6'0"							
	33¾/16"	1660	2060	2660	3060E	3660E	4060E	



NVH1-3350 & NVH1-3054 meet Egress but are not shown.
 E: Denotes a unit that meets Egress.

Envision Double Hung Windows

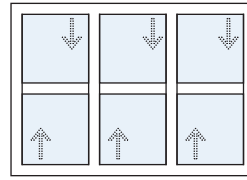
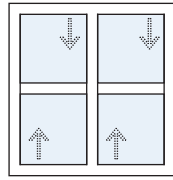
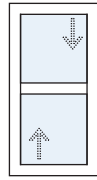

Common Frame

Common Frame

	NVDH1		NVDH2		NVDH3	
	Min	Max	Min	Max	Min	Max
W	17"	48"	35.5"	96"	53.5"	110"
H	27"	78"	27"	78"	27"	78"

Add-On Jamb Dimensions

Wall Thickness	6 ³ / ₁₆ "	6 ¹³ / ₁₆ "
Jamb Size	4 ¹ / ₂ "	4 ³ / ₄ "

Profile Measurements

Overall Frame Size	3 ¹ / ₄ "
Nail Fin Outboard	1 ¹ / ₈ "
Nail Fin Inboard	2 ¹ / ₁₆ "
Nail Fin Width	1 ¹ / ₈ "

NVDH

Daylight Openings

	W	1'6"	2'0"	2'6"	3'0"	3'6"	4'0"
H	Envision Double Hung (NVDH1)						
2'6"		1.76	2.69	3.62	4.56	5.48	6.42
3'0"		2.23	3.41	4.60	5.78	6.96	8.14
3'6"		2.70	4.14	5.56	7.00	8.43	9.86
4'0"		3.18	4.86	6.54	8.22	9.90	11.58
4'6"		3.64	5.58	7.50	9.44	11.38	13.30
5'0"		4.12	6.30	8.48	10.66	12.84	15.02
5'6"		4.58	7.02	9.45	11.88	14.32	16.75
6'0"		5.06	7.74	10.42	13.10	15.78	18.47

Envision Double Hung Windows

Unit Dimensions		1'5½"	1'11½"	2'5½"	2'11½"	3'5½"	3'11½"
Rough Opening		1'6"	2'0"	2'6"	3'0"	3'6"	4'0"
Operating Glass		12¾"	18¾"	24¾"	30¾"	36¾"	42¾"
Top Sash 1" Narrower		11¾"	17¾"	23¾"	29¾"	35¾"	41¾"
2'5½"	2'6"						
	12⅞"	1626	2026	2626	3026	3626	4026
2'11½"	3'0"						
	15⅞"	1630	2030	2630	3030	3630	4030
3'5½"	3'6"						
	18⅞"	1636	2036	2636	3036	3636	4036
3'11½"	4'0"						
	21⅞"	1640	2040	2640	3040	3640	4040
4'5½"	4'6"						
	24⅞"	1646	2046	2646	3046	3646	4046
4'11½"	5'0"						
	27⅞"	1650	2050	2650	3050	3650E	4050E
5'5½"	5'6"						
	30⅞"	1656	2056	2656	3056E	3656E	4056E
5'11½"	6'0"						
	33⅞"	1660	2060	2660	3060E	3660E	4060E

NVDH

NVDH1-3350 & NVDH1-3054 meet Egress but are not shown.

E: Denotes a unit that meets Egress.

Envision Glider Windows

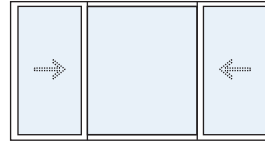
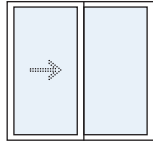

	NVG1		NVGE	
	Min	Max	Min	Max
W	27"	96"	59.5"	110"
H	15.5"	72"	15.5"	72"

Add-On Jamb Dimensions

Wall Thickness	6 ⁵ / ₁₆ "	6 ¹³ / ₁₆ "
Jamb Size	4 ¹ / ₂ "	4 ³ / ₄ "

Profile Measurements

























































Overall Frame Size	3 ¹ / ₄ "
Nail Fin Outboard	1 ¹ / ₈ "
Nail Fin Inboard	2 ¹ / ₁₆ "
Nail Fin Width	1 ¹ / ₈ "

Daylight Openings

	W	2'6"	3'0"	3'6"	4'0"	4'6"	5'0"	5'6"	6'0"	6'6"	7'0"	7'6"	8'0"
H	Envision Glider (NVG1)												
2'0"	2.84	3.61	4.36	5.12	5.89	6.64	7.41						
2'6"	3.78	4.79	5.80	6.81	7.83	8.83	9.84						
3'0"	4.71	5.97	7.23	8.50	9.75	11.02	12.28						
3'6"	5.65	7.16	8.67	10.18	11.69	13.20	14.72						
4'0"		8.34	10.11	11.87	13.62	15.39	17.14						
4'6"		9.53	11.54	13.55	15.56	17.57	19.58						
5'0"		10.71	12.98	15.23	17.50	19.76	22.01						
	Envision Glider End Vent (NVGE)												
2'6"									10.46	11.47	12.48	13.49	14.50
3'0"									13.04	14.31	15.57	16.82	18.10
3'6"									15.64	17.14	18.66	20.16	21.68
4'0"									18.22	19.98	21.75	23.49	25.25
4'6"									20.80	22.81	24.82	26.82	28.85
5'0"									23.40	25.65	27.91	30.18	32.43
	Envision Double Glider (NVDG)												
2'0"	2.54	3.24	3.94	4.64	5.34	6.02	6.72						
2'6"	3.46	4.42	5.36	6.30	7.24	8.20	9.14						
3'0"	4.38	5.58	6.78	7.96	9.16	10.36	11.56						
3'6"	5.30	6.74	8.20	9.64	11.08	12.52	13.98						
4'0"		7.92	9.60	11.30	13.00	14.70	16.38						
4'6"		9.08	11.02	12.96	14.92	16.86	18.80						
5'0"		10.24	12.44	14.64	16.84	19.02	21.22						

NVG

Envision Glider Windows

		Unit Dimensions	2'5½"	2'11½"	3'5½"	3'11½"	4'5½"	4'11½"	5'5½"	5'11½"	
		Rough Opening	2'6"	3'0"	3'6"	4'0"	4'6"	5'0"	5'6"	6'0"	
		Operating Glass	12¾"	15¾"	18¾"	21¾"	24¾"	27¾"	30¾"	33¾"	
1'11½"	2'0"										
	18¾"		2620	3020	3620	4020	4620	5020	5620	6020	
	2'5½"		2'6"								
	24¾"		2626	3026	3626	4026	4626	5026	5626	6026	
	2'11½"		3'0"								
	30¾"		2630	3030	3630	4030	4630	5030	5630E	6030E	
	3'5½"		3'6"								
	36¾"		2636	3036	3636	4036	4636E	5036E	5636E	6036E	
3'11½"	4'0"										
42¾"	3040	3640	4040E	4640E	5040E	5640E	6040E				
4'5½"	4'6"										
48¾"	3046	3646	4046E	4646E	5046E	5646E	6046E				
4'11½"	5'0"										
54¾"	3050	3650	4050E	4650E	5050E	5650E	6050E				

E: Denotes a unit that meets Egress.



Envision Glider Windows

	Unit Dimensions	5'11½"	6'5½"	6'11½"	7'5½"	7'11½"
	Rough Opening	6'0"	6'6"	7'0"	7'6"	8'0"
	Operating Glass	14 ¹⁵ / ₁₆ "	16 ⁷ / ₁₆ "	17 ¹⁵ / ₁₆ "	19 ⁷ / ₁₆ "	20 ¹⁵ / ₁₆ "
2'5½"						
		6026	6626	7026	7626	8026
2'11½"						
		6030	6630	7030	7630	8030
3'5½"						
		6036	6636	7036	7636	8036
3'11½"						
		6040	6640	7040	7640	8040E
4'5½"						
		6046	6646	7046	7646	8046E
4'11½"						
		6050	6650	7050	7650	8050E

E: Denotes a unit that meets Egress.

NVG

Envision Glider Windows

		Unit Dimensions								
		2'5½"	2'11½"	3'5½"	3'11½"	4'5½"	4'11½"	5'5½"	5'11½"	
		Rough Opening								
		2'6"	3'0"	3'6"	4'0"	4'6"	5'0"	5'6"	6'0"	
		Operating Glass								
		11 ⁵ / ₁₆ "	14 ⁵ / ₁₆ "	17 ⁵ / ₁₆ "	20 ⁵ / ₁₆ "	23 ⁵ / ₁₆ "	26 ⁵ / ₁₆ "	29 ⁵ / ₁₆ "	32 ⁵ / ₁₆ "	
1'11½"	2'0"									
	17 ⁵ / ₈ "	2620	3020	3620	4020	4620	5020	5620	6020	
	2'5½"	2'6"								
		23 ⁵ / ₈ "	2626	3026	3626	4026	4626	5026	5626	6026
	2'11½"	3'0"								
		29 ⁵ / ₈ "	2630	3030	3630	4030	4630	5030	5630E	6030E
	3'5½"	3'6"								
		35 ⁵ / ₈ "	2636	3036	3636	4036	4636	5036E	5636E	6036E
	3'11½"	4'0"								
		41 ⁵ / ₈ "	3040	3640	4040	4640E	5040E	5640E	6040E	
4'5½"	4'6"									
	47 ⁵ / ₈ "	3046	3646	4046	4646E	5046E	5646E	6046E		
4'11½"	5'0"									
	53 ⁵ / ₈ "	3050	3650	4050	4650E	5050E	5650E	6050E		

E: Denotes a unit that meets Egress.



Envision Picture Windows

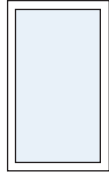

NVPWH & NVPWG		
	Min	Max
W	11"	96"
H	11"	96"

Add-On Jamb Dimensions

Wall Thickness	6 ⁹ / ₁₆ "	6 ¹³ / ₁₆ "
Jamb Size	4 ¹ / ₂ "	4 ³ / ₄ "

Profile Measurements

Overall Frame Size	3 ¹ / ₄ "
Nail Fin Outboard	1 ¹ / ₈ "
Nail Fin Inboard	2 ¹ / ₁₆ "
Nail Fin Width	1 ¹ / ₈ "

Daylight Openings

	W	1'6"	2'0"	2'6"	3'0"	3'6"	4'0"	4'6"
H	Envision Picture Window (NVPW)							
1'6"		1.07	1.59	2.11	2.63	3.15	3.67	4.18
2'0"		1.59	2.36	3.13	3.90	4.67	5.43	6.20
2'6"		2.11	3.13	4.15	5.17	6.18	7.20	8.22
3'0"		2.63	3.90	5.17	6.43	7.70	8.97	10.24
3'6"		3.15	4.67	6.18	7.70	9.22	10.74	12.26
4'0"		3.67	5.43	7.20	8.97	10.74	12.51	14.27
4'6"		4.18	6.20	8.22	10.24	12.26	14.27	16.29
5'0"		4.70	6.97	9.24	11.51	13.77	16.04	18.31
5'6"		5.22	7.74	10.26	12.77	15.29	17.81	
6'0"		5.74	8.51	11.27	14.04	16.81	19.58	

















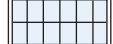



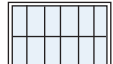



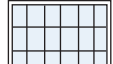



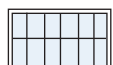

NVPW

Envision Picture Windows

		Unit Dimensions	1'5½"	1'11½"	2'5½"	2'11½"	3'5½"	3'11½"
		Rough Opening	1'6"	2'0"	2'6"	3'0"	3'6"	4'0"
		Glass Size	13¾"	19¾"	25¾"	31¾"	37¾"	43¾"
1'5½"	1'6"	NVPWH ENVISION PICTURE WINDOW						
	13¾"		1616	2016	2616	3016	3616	4016
1'11½"	2'0"	(GRIDS MATCH ENVISION HUNG WINDOWS)						
	19¾"		1620	2020	2620	3020	3620	4020
2'5½"	2'6"							
	25¾"		1626	2026	2626	3026	3626	4026
2'11½"	3'0"							
	31¾"		1630	2030	2630	3030	3630	4030
3'5½"	3'6"							
	37¾"		1636	2036	2636	3036	3636	4036
3'11½"	4'0"							
	43¾"		1640	2040	2640	3040	3640	4040
4'5½"	4'6"							
	49¾"		1646	2046	2646	3046	3646	4046
4'11½"	5'0"							
	55¾"		1650	2050	2650	3050	3650	4050
5'5½"	5'6"							
	61¾"		1656	2056	2656	3056	3656	4056
5'11½"	6'0"							
	67¾"		1660	2060	2660	3060	3660	4060

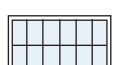
NVPW

Envision Picture Windows

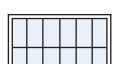
		Unit Dimensions	2' 5½"	2' 11½"	3' 5½"	3' 11½"
		Rough Opening	2' 6"	3' 0"	3' 6"	4' 0"
		Glass Size	25¾"	31¾"	37¾"	43¾"
1' 5½" 1' 6" 1' 11½" 2' 5½" 2' 11½" 3' 5½" 3' 11½" 4' 5½" 4' 11½" 5' 0"	1' 6"	NVPWG ENVISION PICTURE WINDOW				
	1' 11½"	(GRIDS MATCH ENVISION GLIDERS)	2616	3016	3616	4016
	2' 5½"					
	2' 11½"		2620	3020	3620	4020
	3' 5½"					
	3' 11½"		2626	3026	3626	4026
	4' 5½"					
	4' 11½"		2630	3030	3630	4030
	1' 6"					
	1' 11½"		2636	3036	3636	4036
	2' 5½"					
	2' 11½"		2640	3040	3640	4040
	3' 5½"					
	3' 11½"		2646	3046	3646	4046
	4' 5½"					
	4' 11½"		2650	3050	3650	4050

NVPW

Envision Picture Windows

		Unit Dimensions	4'5½"	4'11½"	5'5½"	5'11½"
		Rough Opening	4'6"	5'0"	5'6"	6'0"
		Glass Size	49¾"	55¾"	61¾"	67¾"
1'5½"	1'6"	NVPWG ENVISION PICTURE WINDOW				
	1'11½"		4616	5016	5616	6016
	1'11½"	(GRIDS MATCH ENVISION GLIDERS)				
			4620	5020	5620	6020
	2'5½"					
			4626	5026	5626	6026
	2'11½"					
			4630	5030	5630	6030
	3'5½"					
			4636	5036	5636	6036
3'11½"						
		4640	5040	5640	6040	
4'5½"						
		4646	5046			
4'11½"						
5'0"						
5'5½"						

NVPW

Envision Special Shapes

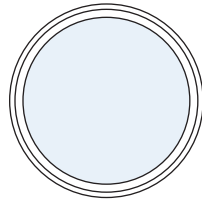

Full Circle

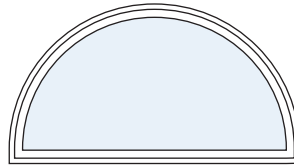

Half Round

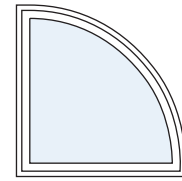

Quarter Round

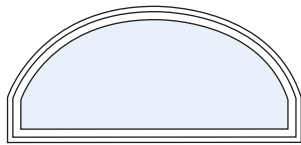

Modified Arch

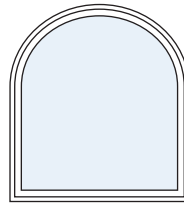

Tall Arch

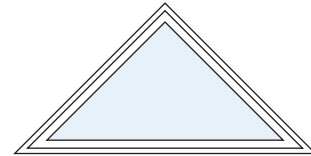

Triangle

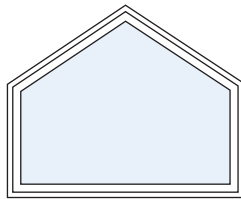

Pentoid

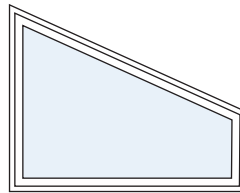

Trapezoid

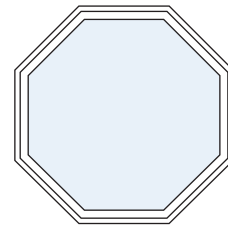

Octagon

NVSP

Profile Measurements

Overall Frame Size	3 ¹ / ₄ "
Nail Fin Outboard	1 ¹ / ₈ "
Nail Fin Inboard	2 ¹ / ₁₆ "
Nail Fin Width	1 ¹ / ₈ "

Optional extension jambs and casing available. All shapes available custom sized.

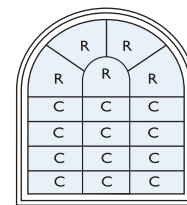

The sample shown features the following lites:
 Radius (R): 5 Lites
 Colonial (C): 12 Lites

Custom Grille Layouts

Envision Bays & Bows

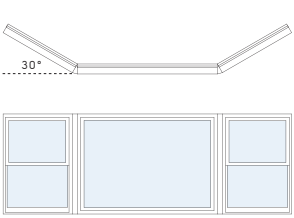

3 Unit Bay Window 30°

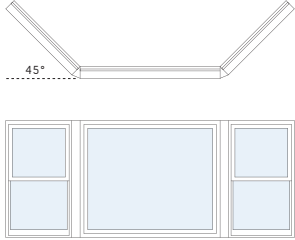

3 Unit Bay Window 45°

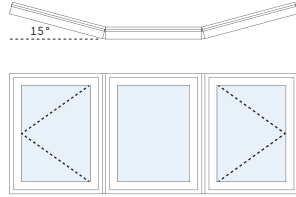

3 Unit Bow Window 15°

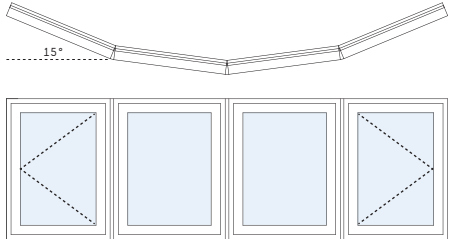

4 Unit Bow Window 15°

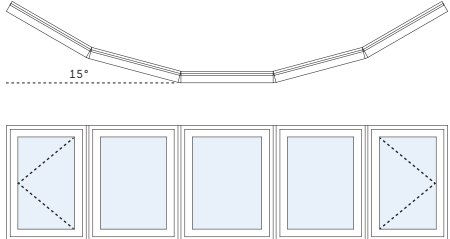

5 Unit Bow Window 15°

Width	Approximate Projection		
	15 Degree	30 Degree	45 Degree
3 Unit Bow			
48" - 60"	6"	7"	13"
61" - 72"	8"	9"	16"
73" - 84"	9"	11"	
85" - 96"	10"	13"	
97" - 108"		14"	
109" - 144"		16"	
4 Unit Bow			
64" - 72"	9"		
73" - 84"	10"		
85" - 96"	12"		
97" - 108"	13"		
109" - 144"	15"		
5 Unit Bow			
85" - 96"	15"		
97" - 108"	16"		
109" - 144"	18"		

NVBW

Full View Sliding Patio Doors

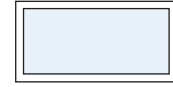
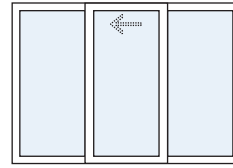
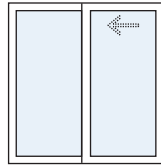
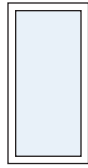

FVPD Mullled

	FVPDSL		FVPD		FVPD/FVPDSL		FVPDT	
	Min	Max	Min	Max	Min	Max	Min	Max
W	11.5"	47.5"	47.5"	95.5"	N/A	144"	11.5"	95.5"
H	59.5"	95.5"	59.5"	95.5"	N/A	106"	11.5"	95.5"

*Height and width cannot exceed 180 united inches

Add-On Jamb Dimensions

Wall Thickness	6 ⁹ / ₁₆ "	6 ¹³ / ₁₆ "
Jamb Size	3 ³ / ₄ "	4"

Profile Measurements

Overall Frame Size	4 ⁵ / ₁₆ "
Nail Fin Outboard	1 ⁷ / ₁₆ "
Nail Fin Inboard	2 ¹³ / ₁₆ "
Nail Fin Width	1 ¹ / ₁₆ "

Daylight Openings

	W	2'6 ¹ / ₄ "	3'3 ¹ / ₄ "	4'1 ¹ / ₄ "	5'0"	6'0"	6'4"	8'0"
H	Patio Door Sidelite (FVPDSL)							
6'8"		13.07	16.07	22.09				
	Slide Patio Door (FVPD)							
6'8"					26.14	32.14	34.16	44.18
6'10"						33.04		45.40
	Patio Transom Unit (FVPDT)							
1'6"					5.35	6.50		
2'0"					7.68	9.33		

FVPD

Full View Sliding Patio Doors

6'7½"	Unit Dimensions	2'5¾"	2'11¼"	3'11¼"	
	Rough Opening	2'6¼"	3'¾"	4'¼"	
	Operating Glass	27"	33"	45"	
	<p>FVPDSL PATIO DOOR SIDELITE</p> <p>2668 3068 4068</p>				
6'8"	Unit Dimensions	4'11½"	5'11½"	6'3½"	7'11½"
	Rough Opening	5'0"	6'0"	6'4"	8'0"
	Operating Glass	27"	33"	35"	45"
	<p>FVPD SLIDE PATIO DOOR</p> <p>5068 6068 6468 8068</p>				
6'7½"	Unit Dimensions	4'11½"	5'11½"	6'3½"	7'11½"
	Rough Opening	5'0"	6'0"	6'4"	8'0"
	Operating Glass	27"	33"	35"	45"
	<p>FVPD SLIDE PATIO DOOR</p> <p>5068 6068 6468 8068</p>				
6'10"	Unit Dimensions	5'11½"	7'11½"		
	Rough Opening	6'0"	8'0"		
	Operating Size	33"	45"		
	<p>FVPD SLIDE PATIO DOOR</p> <p>60610 80610</p>				
1'5½"	Unit Dimensions	4'11½"	5'11½"		
	Rough Opening	5'0"	6'0"		
	Glass Size	56¾"	68¾"		
	<p>FVPDT PATIO TRANSOM UNIT</p> <p>5016 6016</p>				
1'11½"	Unit Dimensions	4'11½"	5'11½"		
	Rough Opening	5'0"	6'0"		
	Glass Size	56¾"	68¾"		
	<p>FVPDT PATIO TRANSOM UNIT</p> <p>5020 6020</p>				

FVPDSL Notes: R.O. Width ¼" Larger Than Call Out
 Mull to FVPD R.O. = sum of call out.
 Example: FVPDSL 3068 mull to FVPD 6068 = R.O. 9'0" x 6'8".

FVPD

French Sliding Patio Doors



FSD Muller

	FSD		FSD/FSDSL		FSDSL		FSDTS	
	Min	Max	Min	Max	Min	Max	Min	Max
W	59.5"	95.5"	N/A	144"	17.5"	47.5"	11.5"	95.5"
H	59.5"	95.5"	N/A	106"	59.5"	95.5"	11.5"	95.5"

Profile Measurements

Overall Frame Size	4 ⁹ / ₁₆ "
Nail Fin Outboard	1 ¹ / ₄ "
Nail Fin Inboard	3 ¹ / ₄ "
Nail Fin Width	1 ¹ / ₄ "

Daylight Openings

	W	2'10"	3'4"	5'0"	6'0"	8'0"
H	Patio Door Sidelite (FSPDSL)					
6'8"		10.71	13.58			
	Slide Patio Door (FSD)					
6'8"				21.42	27.16	38.26
6'10"					27.94	39.74
	Patio Transom Unit (FSDTS)					
1'0"		1.75	2.10	3.25	3.94	
1'6"		3.01	3.61	5.60	6.79	
2'0"		4.28	5.12	7.94	9.64	

French Sliding Patio Doors

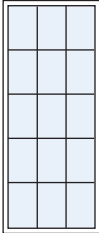
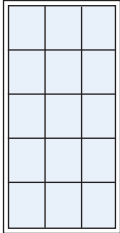
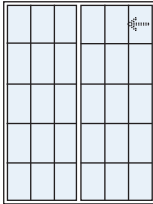
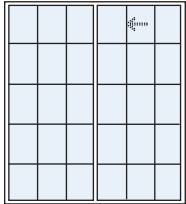
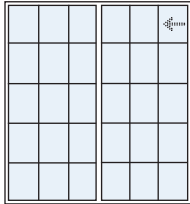
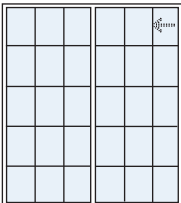
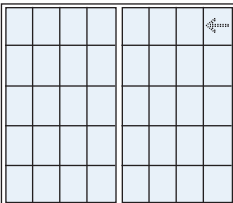
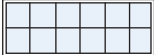
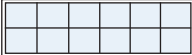
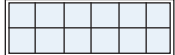
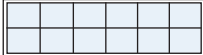
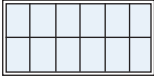
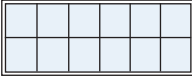
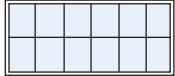
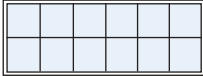
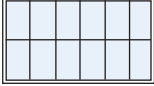
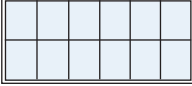
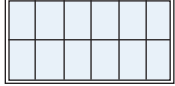
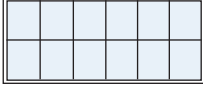
6' 7 1/2"	6' 8"	69 1/4"	FDSL PATIO DOOR SIDELITE	Unit Dimensions	2' 9 1/2"	3' 3 1/2"		
				Rough Opening	2' 10"	3' 4"		
				Glass Size	23 3/8"	29 3/8"		
								
				21068	3468			
6' 7 1/2"	6' 8"	69 1/4"	FSD SLIDE PATIO DOOR	Unit Dimensions	4' 11 1/2"	5' 11 1/2"	7' 11 1/2"	
				Rough Opening	5' 0"	6' 0"	8' 0"	
				Operating Glass	23 3/8"	29 3/8"	41 3/8"	
								
				5068	6068	8068		
6' 9 1/2"	6' 10"	75 1/8"	FSD SLIDE PATIO DOOR	Unit Dimensions	5' 11 1/2"	7' 11 1/2"		
				Rough Opening	6' 0"	8' 0"		
				Operating Size	33"	45"		
								
				60610	80610			
11 1/2"	1' 0"	9 3/8"	FSDTS PATIO TRANSOM UNIT	Unit Dimensions	2' 9 1/2"	3' 3 1/2"	4' 11 1/2"	5' 11 1/2"
				Rough Opening	2' 10"	3' 4"	5' 0"	6' 0"
				Glass Size	31 3/8"	37 3/8"	57 3/8"	69 3/8"
								
				21010	3410	5010	6010	
								
				21016	3416	5016	6016	
								
				21020	3420	5020	6020	

FSD

Test Performance Data

All Envision products meet or exceed the published results shown below for structural strength and air infiltration. Furthermore, all Vector windows and doors are tested and certified for thermal performance by National Fenestration Rating Council (NFRC). Quality and performance are assured through testing and plant inspections.

All data provided in accordance with all American Society for Testing and Materials (ASTM) guidelines set forth in NFRC-100/200/500 and AAMA / WDMA/CSA 101/I.S. 2/A440, NAFS - North American Fenestration Standard/Specification for Windows, Doors and Skylights.

Due to continued ongoing product testing, the information provided can be changed by Vector at any time without notification. This data supersedes any previous data published by Vector.

Structural Performance Data

Product	Size Tested	Performance Grade	Air Infiltration	Water Resistance
Advantage Single Hung Window	48" X 78"	H-LC30	.14 CFM/FT ²	6.90 PSF
Advantage Single Glider Window	72" X 60"	HS-R20	.12 CFM/FT ²	5.43 PSF
Advantage Picture Window	60" X 60"	LC-PG30	<.01 CFM/FT ²	6.00 PSF
Envision Casement Window	36" X 75"	R-PG50	.02 CFM/FT ²	11.28 PSF
Envision Awning Window	48" X 32"	LC-PG55	.02 CFM/FT ²	12.11 PSF
Envision Casement Fixed Window	72" X 75"	CW-PG50	<.01 CFM/FT ²	12.11 PSF
Envision Single Hung Window	48" X 75"	LC-PG45	.04 CFM/FT ²	7.52 PSF
Envision Double Hung Window	48" X 75"	LC-PG40	.05 CFM/FT ²	8.35 PSF
Envision Single Glider Window	72" X 60"	LC-PG40	.11 CFM/FT ²	6.06 PSF
Envision Double Glider Window	72" X 60"	LC-PG25	.07 CFM/FT ²	9.19 PSF
Envision End Vent Glider (1/4-1/2-1/4)	108" X 60"	LC-PG35	.11 CFM/FT ²	5.43 PSF
Envision End Vent Glider (1/3-1/3-1/3)	108" X 60"	LC-PG35	.11 CFM/FT ²	5.43 PSF
Envision Picture Window	72" X 75"	CW-PG35	.01 CFM/FT ²	12.11 PSF
Full View Sliding Patio Door	96" X 80"	R-PG20	.10 CFM/FT ²	5.43 PSF
French Sliding Patio Door	96" X 82"	R-PG40	.07 CFM/FT ²	7.50 PSF

Air Infiltration: ASTM E283 cubic feet per minute of air leakage per square footage of window or door.

Structural Performance: ASTM E330 pressure shown applied positive and negative to unit and held for 10 seconds, with no damage allowed.

Forced Entry Resistance: ASTM F 588 for windows, ASTM F 842 for patio doors.

Please go to Vector Windows website to see most current performance data.

www.vectorwindows.com

Test Performance Data

NFRC: Thermal & Solar Values		U-Value	R-Value	Solar Heat Gain		Visible Light		Condensation Resistance
		with or w/o Grilles	with or w/o Grilles	w/o Grilles	with Grilles	w/o Grilles	with Grilles	with or w/o Grilles
Product								
Advantage Single Hung Window	LOE3	0.28	3.57	0.22	0.20	0.51	0.46	62
	LOE2	0.29	3.45	0.33	0.30	0.57	0.51	61
Advantage Single Glider Window	LOE3	0.28	3.57	0.22	0.20	0.51	0.46	62
	LOE2	0.29	3.45	0.33	0.30	0.57	0.51	62
Advantage Picture Window	LOE3	0.26	3.85	0.25	0.22	0.57	0.51	64
	LOE2	0.27	3.70	0.37	0.34	0.64	0.57	63
Envision Casement Dual Pane	LOE3	0.24	4.17	0.21	0.19	0.48	0.44	62
	LOE2	0.25	4.00	0.31	0.29	0.54	0.49	62
Envision Casement Triple Pane	LOE3	0.17	5.88	0.18	0.17	0.35	0.32	71
	LOE2	0.17	5.88	0.27	0.24	0.43	0.39	70
Envision Awning Dual Pane	LOE3	0.25	4.00	0.21	0.19	0.48	0.44	61
	LOE2	0.25	4.00	0.31	0.29	0.54	0.49	60
Envision Awning Triple Pane	LOE3	0.17	5.88	0.18	0.17	0.35	0.32	71
	LOE2	0.17	5.88	0.27	0.24	0.43	0.39	71
Envision Casement Fixed Dual Pane	LOE3	0.24	4.17	0.23	0.21	0.54	0.49	62
	LOE2	0.25	4.00	0.35	0.32	0.60	0.54	61
Envision Casement Fixed Triple Pane	LOE3	0.15	6.67	0.20	0.18	0.39	0.35	71
	LOE2	0.16	6.25	0.30	0.27	0.48	0.43	70
Envision Single Hung Dual Pane	LOE3	0.26	3.85	0.21	0.19	0.51	0.45	62
	LOE2	0.27	3.70	0.32	0.29	0.56	0.50	62
Envision Single Hung Triple Pane	LOE3	0.18	5.56	0.19	0.17	0.36	0.32	71
	LOE2	0.18	5.56	0.28	0.25	0.45	0.40	70
Envision Double Hung Dual Pane	LOE3	0.26	3.85	0.21	0.19	0.49	0.44	62
	LOE2	0.27	3.70	0.32	0.29	0.55	0.49	62
Envision Double Hung Triple Pane	LOE3	0.18	5.56	0.18	0.17	0.36	0.32	71
	LOE2	0.18	5.56	0.27	0.24	0.44	0.39	71

Please go to [Vector Windows website](http://www.vectorwindows.com) to see most current performance data.
www.vectorwindows.com

Test Performance Data

NFRC: Thermal & Solar Values		U-Value		R-Value		Solar Heat Gain		Visible Light		Condensation Resistance
		with or w/o Grilles	with or w/o Grilles	w/o Grilles	with Grilles	w/o Grilles	with Grilles	with or w/o Grilles		
Envision Single Glider Dual Pane	LOE3	0.26	3.85	0.21	0.19	0.50	0.45	63		
	LOE2	0.27	3.70	0.32	0.29	0.56	0.50	62		
Envision Single Glider Triple Pane	LOE3	0.17	5.88	0.19	0.17	0.36	0.32	74		
	LOE2	0.18	5.56	0.28	0.25	0.45	0.40	74		
Envision Double Glider Dual Pane	LOE3	0.26	3.85	0.21	0.19	0.48	0.43	60		
	LOE2	0.27	3.70	0.31	0.28	0.54	0.48	61		
Envision Double Glider Triple Pane	LOE3	0.18	5.56	0.18	0.16	0.35	0.31	61		
	LOE2	0.19	5.26	0.26	0.24	0.43	0.38	65		
Envision Picture Dual Pane	LOE3	0.25	4.00	0.22	0.20	0.53	0.47	62		
	LOE2	0.26	3.85	0.34	0.31	0.59	0.52	61		
Envision Picture Triple Pane	LOE3	0.16	6.25	0.20	0.18	0.38	0.34	71		
	LOE2	0.17	5.88	0.29	0.26	0.47	0.42	70		
Full View Sliding Patio Door	LOE3	0.27	3.70	0.23	0.20	0.53	0.46	61		
	LOE2	0.28	3.57	0.34	0.30	0.59	0.52	60		
French Sliding Patio Door	LOE3	0.28	3.57	0.19	0.17	0.45	0.39	62		
	LOE2	0.29	3.45	0.29	0.26	0.50	0.44	61		

Please go to [Vector Windows website](http://www.vectorwindows.com) to see most current performance data.
www.vectorwindows.com



Limited Lifetime Warranty

Visit www.vectorwindows.com to view
The Vector Windows Limited Lifetime Warranty.



©2021 Vector Windows and Doors. All rights reserved.
All trademarks are property of their respective owners.



Vector Windows, LLC
1020 International Dr.
Fergus Falls, MN 56537

PHONE 218.998.6410
FAX 888.739.9799

VectorWindows.com

